

Front Frame for EMC Shielding for Horizontal Boards Mounting, 3 U, 20 HP

KATALOGNUMMER

24564-109

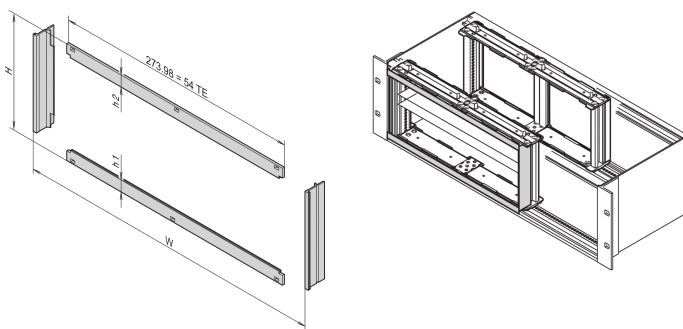

Front frame installation provides the contact between subracks and assemblies. It must be used if a customer has selected a horizontal board mounting Kit.

CERTIFICERINGER



FUNKTIONER

Front frame installation provides the contact between subracks and assemblies

PRODUKTEGENSKABER

Rack Height: 3U

Rack Width: 20HP

Pakke mængde: 1

Finish: Anodized; Passivated

Materiale: Aluminium

Produktfamilie: EuropacPRO

Product Type: Side Panel

Works With: Subracks

Net Weight: 0.1kg

YDERLIGERE PRODUKTOPLYSNINGER

H=128.40 mm, h1=h2= 13.23 mm.

EMC contact strip, stainless steel, see Sub-assemblies/Front panels.

Please order accessories separately.

ADVARSEL

nVent-produkter skal kun installeres og anvendes som angivet i nVents produktvejledninger og træningsmaterialer. Vejledninger er tilgængelige på www.nvent.com og hos din nVent kundeservicerepræsentant. Forkert installation, misbrug, fejlanvendelse eller anden unkladelse af fuldt ud at følge nVents instruktioner og advarsler kan medføre funktionsfejl, materielle skader, alvorlige personskader eller død og/eller ugyldiggøre din garanti.

North America

All locations
+1.763.422.2661
Chat with us:
nvent.com/schroff

Europe

Straubenhardt, Germany
+49.7082.794.0
Betschdorf, France
+33.3.88.90.64.90
Warsaw, Poland
+48.22.209.98.35
Assago, Italy
+39.02.932.7141
Chat with us:
nvent.com/schroff

Asia

Shanghai, China
+86.21.2412.6943
Qingdao, China
+86.532.8771.6101
Singapore
+65.6768.5800
Shin-Yokohama, Japan
+81.45.476.0271
Chat with us:
nvent.com/schroff

Middle East & India

Dubai, United Arab
Emirates
+971.4.378.1700
Bangalore, India
+91.80.6715.2001
Istanbul, Turkey
+90.216.250.7374
Chat with us:
nvent.com/schroff



Vores kraftfulde portefølje af mærker:

CADDY ERICO HOFFMAN ILSCO SCHROFF TRACHTE