

Guide Rail Standard Type, PC, 340 mm, 2 mm Groove Width, Multi-Piece, Red/Silver, 10 Pieces

KATALOGNUMMER

24568-380

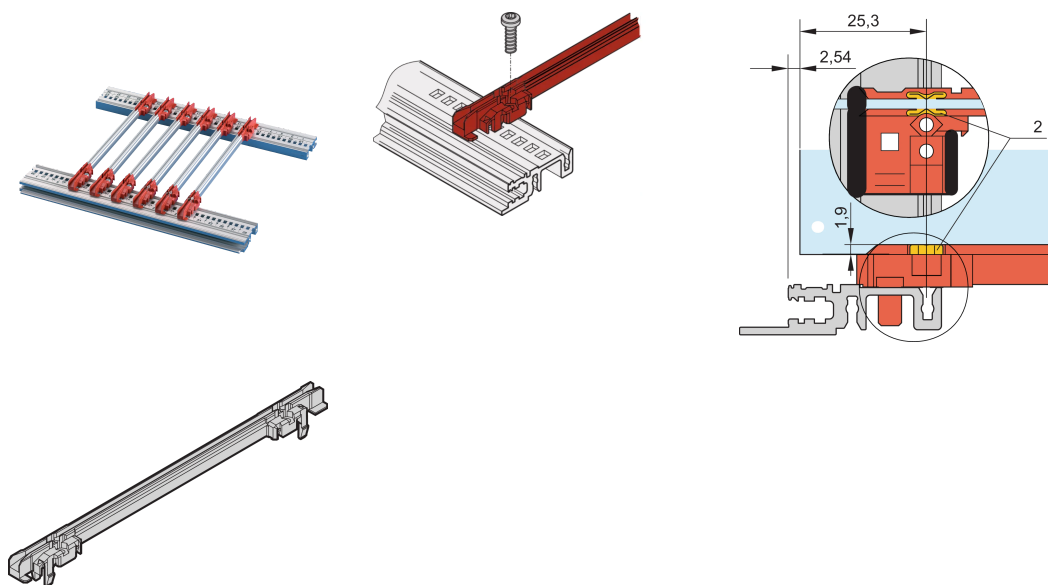

New generation of accessory type guide rails for PCBs or plug-in units. Forms a reliable interface between the subrack mechanics and the sub-assemblies.

CERTIFICERINGER



FUNKTIONER

NEW generation Standard type plastic guide rails for reliable retention of PCBs or plug-in units

Significantly increased stability, due to a optimized design and high quality material (PC)

Improved fire safety properties, fulfills EN 45545-2 requirement sets R22, R23 and R24 with HL3

"Halogen-Free", according to IEC 61249-2-21

Can be clipped into horizontal rails (Al extrusion) or into 1.5 mm thick plates

Can be bolted to the horizontal rails Type H and R for higher shock and vibration requirements

Optional ESD clip for an conductive contact between PCB and horizontal rail available

Storage temperature: from -40 °C ... 130 °C

PRODUKTEGENSKABER

Farve: Red

Pakke mængde: 10

Board Depth: 340mm

Groove Width: 2

Complies With: EN 45545-2

Materiale: Fiber-Reinforced Plastic

Produktfamilie: EuropacPRO; RatiopacPRO; RatiopacPRO AIR; CompacPRO; PropacPRO; MultipacPRO; Inpac

Product Type: Guide Rail

Type: Standard

Works With: Subracks; Cases; 19" Chassis; Systems

Net Weight: 0.2kg

YDERLIGERE PRODUKTOPLYSNINGER

Please take into consideration that deliveries may be carried out in the stated SPQs (SPQ, e.g. 5 pieces, 10 pieces, 50 pieces, etc.). Differing order quantities (e.g. 2 pieces) may be changed to the next possible delivery quantity = Standard Pack Quantity.

ADVARSEL

nVent-produkter skal kun installeres og anvendes som angivet i nVents produktvejledninger og træningsmaterialer. Vejledninger er tilgængelige på www.nvent.com og hos din nVent kundeservicerepræsentant. Forkert installation, misbrug, fejlanvendelse eller anden unkladelse af fuldt ud at følge nVents instruktioner og advarsler kan medføre funktionsfejl, materielle skader, alvorlige personskader eller død og/eller ugyldiggøre din garanti.

North America

All locations

+1.763.422.2661

Chat with us:

nvent.com/schroff

Europe

Straubenhardt, Germany

+49.7082.794.0

Betschdorf, France

+33.3.88.90.64.90

Warsaw, Poland

+48.22.209.98.35

Assago, Italy

+39.02.932.7141

Chat with us:

nvent.com/schroff

Asia

Shanghai, China

+86.21.2412.6943

Qingdao, China

+86.532.8771.6101

Singapore

+65.6768.5800

Shin-Yokohama, Japan

+81.45.476.0271

Chat with us:

nvent.com/schroff

Middle East & India

Dubai, United Arab Emirates

+971.4.378.1700

Bangalore, India

+91.80.6715.2001

Istanbul, Turkey

+90.216.250.7374

Chat with us:

nvent.com/schroff



Vores kraftfulde portefølje af mærker:

CADDY

ERICO

HOFFMAN

ILSCO

SCHROFF

TRACHTE