

PCB Solder Side Cover, CPCI, 6 U, 233.35 mm x 80 mm,

KATALOGNUMMER

24579-039



A solder side cover protects the solder side of a PCB mechanically.

CERTIFICERINGER



FUNKTIONER

Cover is perforated for better cooling of components

Mechanical protection of solder side

PRODUKTEGENSKABER

Rack Height: 6U

Pakke mængde: 1

Dybde (D): 80mm

Materiale: Plastik

Product Type: Cover

Type: Solder Side Cover

Bredde (W): 233.35mm

Works With: Front Panels

Net Weight: 0.014kg

YDERLIGERE PRODUKTOPLYSNINGER

Fixing clips are required for mounting the perforated covers; please order separately.

DIAGRAMS

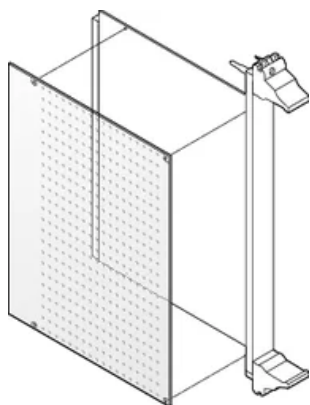

ADVARSEL

nVent-produkter skal kun installeres og anvendes som angivet i nVents produktvejledninger og træningsmaterialer. Vejledninger er tilgængelige på www.nvent.com og hos din nVent kundeservicerepræsentant. Forkert installation, misbrug, fejlanvendelse eller anden undladelse af fuldt ud at følge nVents instruktioner og advarsler kan medføre funktionsfejl, materielle skader, alvorlige personskader eller død og/eller ugyldiggøre din garanti.

North America

All locations
+1.763.422.2661
Chat with us:
nvent.com/schroff

Europe

Straubenhardt, Germany
+49.7082.794.0
Betschdorf, France
+33.3.88.90.64.90
Warsaw, Poland
+48.22.209.98.35
Assago, Italy
+39.02.932.7141
Chat with us:
nvent.com/schroff

Asia

Shanghai, China
+86.21.2412.6943
Qingdao, China
+86.532.8771.6101
Singapore
+65.6768.5800
Shin-Yokohama, Japan
+81.45.476.0271
Chat with us:
nvent.com/schroff

Middle East & India

Dubai, United Arab Emirates
+971.4.378.1700
Bangalore, India
+91.80.6715.2001
Istanbul, Turkey
+90.216.250.7374
Chat with us:
nvent.com/schroff



Vores kraftfulde portefølje af mærker:

CADDY ERICO HOFFMAN ILSCO SCHROFF TRACHTE