

# CNC 2-Screw Clamp for Steel Pipe, 88.9 mm OD, 80 DN, M12 Rod

## CATALOG NUMBER

**CNC80M12**



## FEATURES

Suspends sprinkler fire pipe services

Cup head fastener

Double bolted

## PRODUCT ATTRIBUTES

Material: Steel

Finish: Electrogalvanized

Outer Diameter (OD): 88.9 mm

NB/DN: 80

Rod Size (RS): M12

Screw Diameter (Sc): 1/4"

Screw Length (L): 1"

Width (W): 20 mm

Thickness (T): 3 mm

Static Load: 1500N

## DIAGRAMS

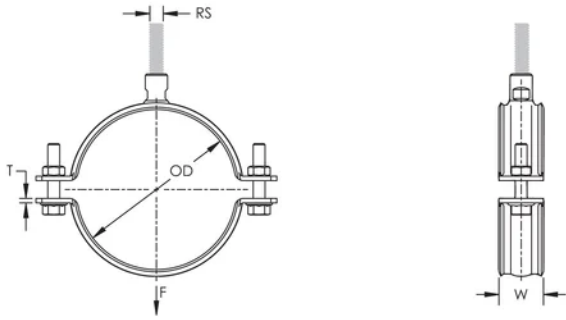

## WARNING

nVent products shall be installed and used only as indicated in nVent's product instruction sheets and training materials. Instruction sheets are available at [www.nvent.com](http://www.nvent.com) and from your nVent customer service representative. Improper installation, misuse, misapplication or other failure to completely follow nVent's instructions and warnings may cause product malfunction, property damage, serious bodily injury and death and/or void your warranty.

### North America

+1.800.753.9221  
Option 1 – Customer Care  
Option 2 – Technical  
Support

### Europe

Netherlands:  
+31 800-0200135  
France:  
+33 800 901 793

### Europe

Germany:  
800 1890272  
Other Countries:  
+31 13 5835404

### APAC

Shanghai:  
+ 86 21 2412 1618/19  
Sydney:  
+61 2 9751 8500



Our powerful portfolio of brands:

**CADDY ERICO HOFFMAN ILSCO SCHROFF TRACHTE**

