

Varistar CP Base/Plinth Side, Plain, RAL 7021, 200H, 900D

Data Solutions

CATALOG NUMBER

24630-082

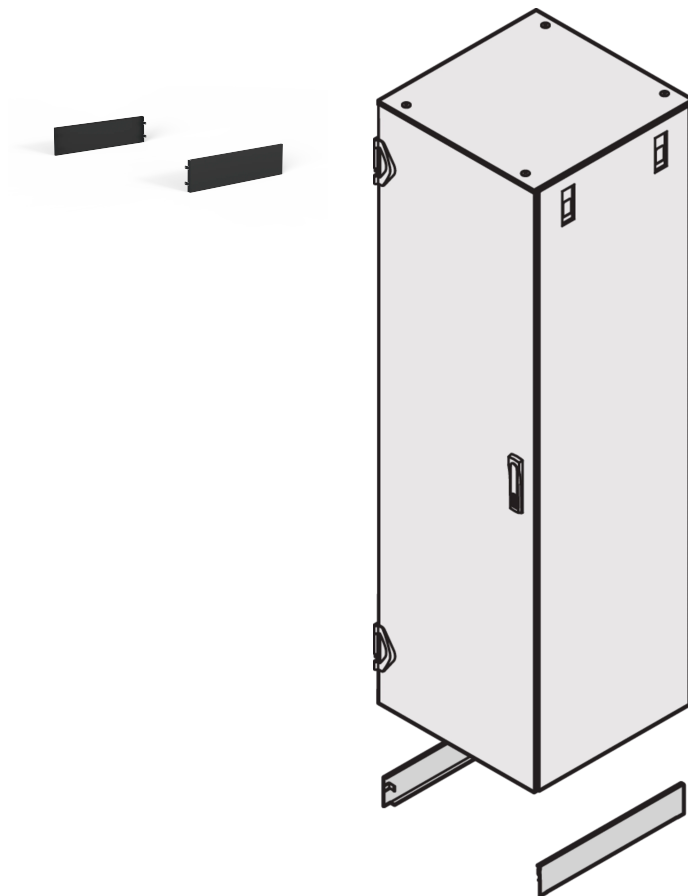

Sides trim to mount to Varistar CP base/plinth

FEATURES

Base/plinth sides, plain

PRODUCT ATTRIBUTES

Height: 200mm

Depth: 900mm

Package Quantity: 1

Color: Black Grey

Color Code: RAL 7021

Finish: Powder Coated

Material: Steel

Product Family: Varistar CP

Product Type: Cabinet/Rack Base

Type: Plinth Side

Package Unit: Pair

Net Weight: 3.326kg

ADDITIONAL PRODUCT DETAILS

Please order base/plinth for front/rear separately.

Cannot be used in conjunction with castors

WARNING

nVent products shall be installed and used only as indicated in nVent's product instruction sheets and training materials. Instruction sheets are available at www.nvent.com and from your nVent customer service representative. Improper installation, misuse, misapplication or other failure to completely follow nVent's instructions and warnings may cause product malfunction, property damage, serious bodily injury and death and/or void your warranty.



Our powerful portfolio of brands:

CADDY

ERICO

HOFFMAN

ILSCO

SCHROFF

TRACHTE