

Air Baffle, Front Panel, Refrofit Shielding, Steel, 6 U, 4 HP, 220 mm

CATALOG NUMBER

20848-721

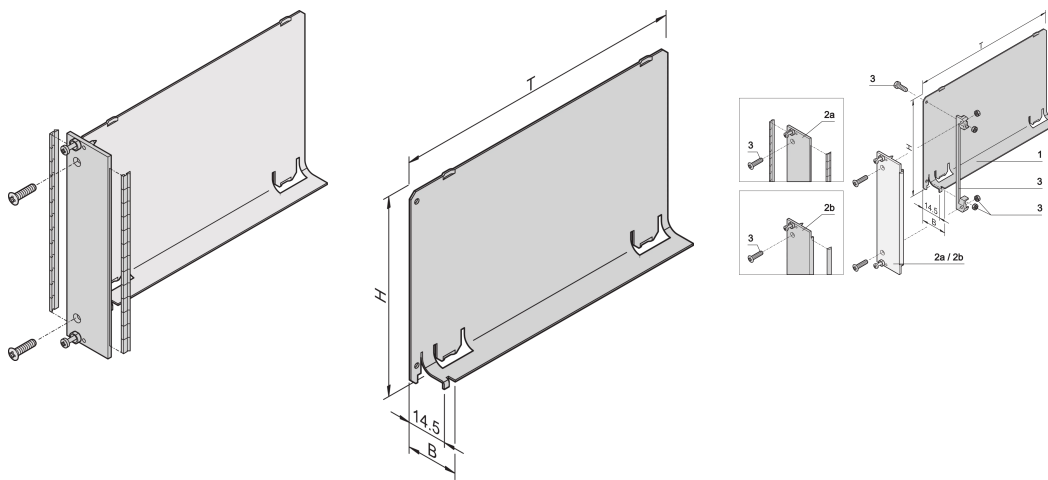

The air baffle with flat front panel covers an empty slot and eliminates an air leak. The flat front panel accepts a stainless steel EMC gasket.

CERTIFICATIONS



FEATURES

Air baffle eliminates air leaks from empty slots

Cover is pushed into the guide rail

PRODUCT ATTRIBUTES

Rack Height: 6U

Package Quantity: 1

Depth: 220mm

EMC Shielding: No (Retrofittable)

Finish: Anodized; Passivated

Material: Aluminum

Product Family: EuropacPRO; RatiopacPRO; RatiopacPRO AIR; CompacPRO; PropacPRO; Inpac

Product Type: Air Baffle

Rack Width: 4HP

Type: With Front Panel

Works With: Subracks; Cases

Net Weight: 0.13kg

ADDITIONAL PRODUCT DETAILS

Air baffle for 280 mm deep and for 80 mm rear I/O boards available on request.

WARNING

nVent products shall be installed and used only as indicated in nVent's product instruction sheets and training materials. Instruction sheets are available at www.nvent.com and from your nVent customer service representative. Improper installation, misuse, misapplication or other failure to completely follow nVent's instructions and warnings may cause product malfunction, property damage, serious bodily injury and death and/or void your warranty.

North America

All locations
+1.763.422.2661
Chat with us:
nvent.com/schroff

Europe

Straubenhardt, Germany
+49.7082.794.0
Betschdorf, France
+33.3.88.90.64.90
Warsaw, Poland
+48.22.209.98.35
Assago, Italy
+39.02.932.7141
Chat with us:
nvent.com/schroff

Asia

Shanghai, China
+86.21.2412.6943
Qingdao, China
+86.532.8771.6101
Singapore
+65.6768.5800
Shin-Yokohama, Japan
+81.45.476.0271
Chat with us:
nvent.com/schroff

Middle East & India

Dubai, United Arab
Emirates
+971.4.378.1700
Bangalore, India
+91.80.6715.2001
Istanbul, Turkey
+90.216.250.7374
Chat with us:
nvent.com/schroff



Our powerful portfolio of brands:

CADDY ERICO HOFFMAN ILSCO SCHROFF TRACHTE