

19" Assembly Kit M6, Screw, Washer, Nut; 50 pieces

Data Solutions

CATALOG NUMBER

21101-809

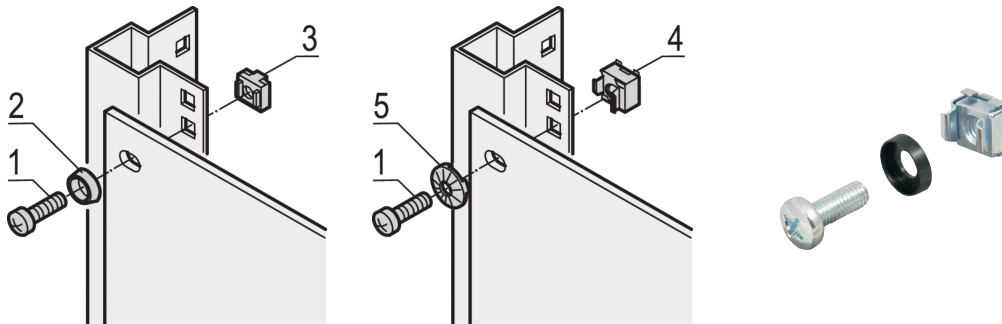

For standard grounding use a grounding nut and washer on at least one attachment point.

When 19" assembly kit is used with conductive 19" panel mount, grounding cage nuts are not needed.

CERTIFICATIONS



FEATURES

Assembly kits for assembly of 19" components into a cabinet

For mounting of front panels, distribution fields or other components on the frame, slide mounts or depth members with square cut-outs

PRODUCT ATTRIBUTES

Package Quantity: 50

Thread Size: M6

Finish: Zinc Plated

Material: Steel; ABS

Product Family: RatiopacPRO; RatiopacPRO AIR; CompacPRO; PropacPRO; Comptec; Inpac; MultipacPRO; Varistar CP; Novastar; Eurorack; Outdoor

Product Type: Assembly Kit

Type: Mounting Kit

Works With: 19" Cases; 19" Wallmount; 19" Indoor Cabinets; 19" Outdoor Cabinets

Net Weight: 0.546kg

WARNING

nVent products shall be installed and used only as indicated in nVent's product instruction sheets and training materials. Instruction sheets are available at www.nvent.com and from your nVent customer service representative. Improper installation, misuse, misapplication or other failure to completely follow nVent's instructions and warnings may cause product malfunction, property damage, serious bodily injury and death and/or void your warranty.



Our powerful portfolio of brands:

CADDY ERICO HOFFMAN ILSCO SCHROFF TRACHTE