

Telescopic Slides C-Profile for Cabinet for Fitting Eurorack, 800 mm

Data Solutions

CATALOG NUMBER

24562-451

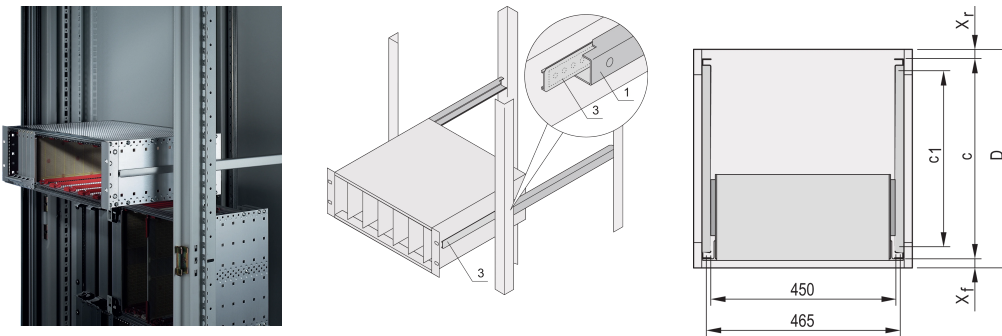

Telescopic slides with guiding profile for fitting in cabinets with 25 kg load capacity.

CERTIFICATIONS



FEATURES

For mounting 84 HP wide subracks in the 19" plane

Loading capacity: 25 kg per pair

The guiding profile (1) is matched to the fixing dimension in the cabinet (it is bolted to the 19" profile of the cabinet); the adaptor Rail (3) is matched to the depth and fixing dimension on the subrack (it is inserted into the guiding profile like a telescopic slide)

PRODUCT ATTRIBUTES

Product Family: Eurorack

Depth: 800mm

Package Quantity: 2

Finish: Anodized

Material: Aluminum

Product Type: Telescopic Slide

Type: C Profile

Net Weight: 0.64kg

ADDITIONAL PRODUCT DETAILS

No protection against extraction, no stop at full extension.

The reinforcement Rail and the C-Rails have been tested in accordance with the Russian atomic energy authority GAN standards.

WARNING

nVent products shall be installed and used only as indicated in nVent's product instruction sheets and training materials. Instruction sheets are available at www.nvent.com and from your nVent customer service representative. Improper installation, misuse, misapplication or other failure to completely follow nVent's instructions and warnings may cause product malfunction, property damage, serious bodily injury and death and/or void your warranty.



Our powerful portfolio of brands:

CADDY ERICO HOFFMAN ILSCO SCHROFF TRACHTE