

# FTTX Fiber Optic Cabinet Package Type 4X Single Battery, 84x30x44, Lt Gray, AL

## Data Solutions

### CATALOG NUMBER

**T843044FTTXDAB**



Pad-mounted FTTX welded aluminum enclosures provide longlasting protection and manage fiber optic cable for broadband delivery in outdoor applications. Provided with or without back-up batter compartment.

### INDUSTRY STANDARDS

UL 508A Listed; Type 3, 3R, 4, 4X, 12; File No. E61997

NEMA/EEMAC Type 3, 3R, 4, 4X, 12

EC60529, IP66

Designed to meet Telcordia NEBS™ GR-487, GR-63 and IEC 48D

EIA 310-D with 19-in. spacing for rack equipment

Cabinet is RoHS compliant

NEBS™ is a trademark of Telcordia

### FEATURES

Standard pitched roof promotes water runoff

Available with either single- or dual-access doors on front and rear for convenient access

Available with or without battery compartment

3-point latching mechanisms and padlocking handles on doors provide security

Seamless foam-in-place gasket seals doors against moisture and dust

Wind latch mechanisms on doors control door when open for equipment maintenance

Removable lifting lugs (2) for easy installation

Rack angles adjustable for 19- or 23-inch spacing without modifications

Use cage nuts to mount equipment

Cabinet top insulation helps prevent the formation of condensation and reduce solar gain inside cabinet. Cabinet side insulation is optional

Base of cabinet has a 5.00-inch (127-mm) high aluminum mounting plinth to allow for cable alignment

Three pyramidal boots provided at base of cabinet for sealing various sizes of cables

All fasteners are stainless steel to maintain professional appearance in severe outdoor climate conditions

## PRODUCT ATTRIBUTES

---

Article Number: 29194

Height (H): 2375mm

Width (W): 762mm

Depth (D): 1283mm

Material: Aluminum

Finish: Powder Coated

Color: Light Gray

Color Code: RAL 7035

Thickness (T): 3mm

Rack Units: 43U

## DIAGRAMS

---

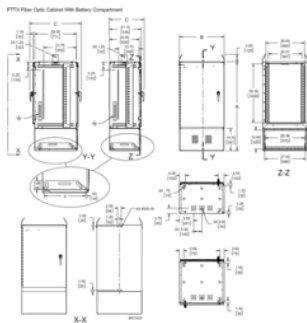

## WARNING

---

nVent products shall be installed and used only as indicated in nVent's product instruction sheets and training materials. Instruction sheets are available at [www.nvent.com](http://www.nvent.com) and from your nVent customer service representative. Improper installation, misuse, misapplication or other failure to completely follow nVent's instructions and warnings may cause product malfunction, property damage, serious bodily injury and death and/or void your warranty.



Our powerful portfolio of brands:

**CADDY   ERICO   HOFFMAN   ILSCO   SCHROFF   TRACHTE**