

# EuropacPRO 19" Subrack Kit for Backplane, Shielded, CompactPCI, 6 U, 275 mm

## CATALOG NUMBER

**24563-457**

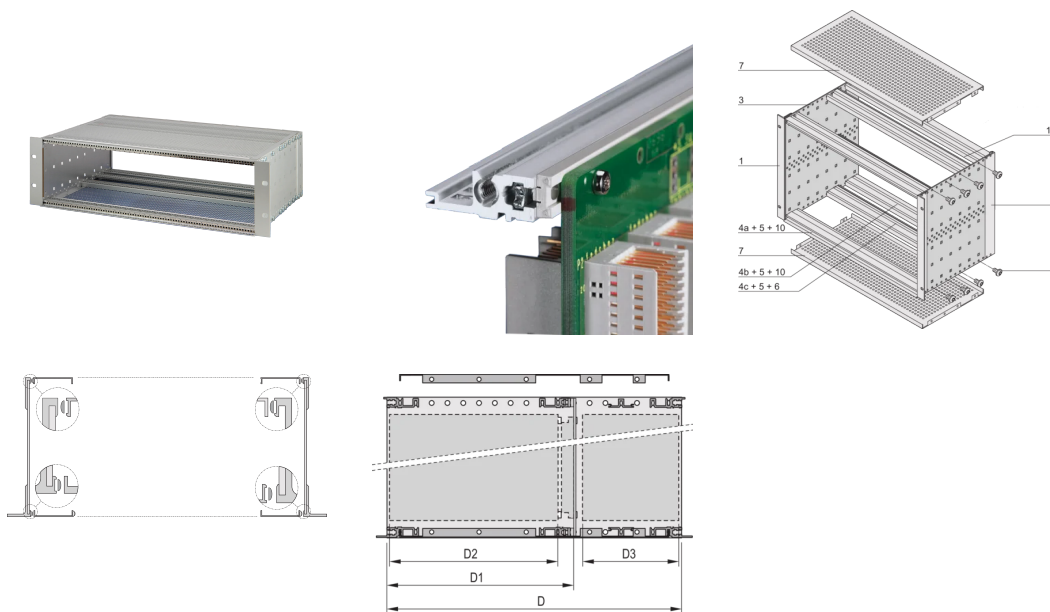

EMC Shielded subrack for backplane mounting, for CPCI application.

## CERTIFICATIONS



## FEATURES

Subrack with side panel type F ("flexible") for CompactPCI plug-in units with high insertion and withdrawal forces

Aluminum construction

Rear horizontal rail for backplane mounting with insulation strip

Internal and external dimensions in accordance with: IEC 60297-3-100, -101, -102, -103, -104, IEEE 1101.1, IEEE 1101.10/11

Modifications such as cutouts, different finishes or dimensions available

EMC of approximately 40 dB at 1 GHz, 30 dB at 2 GHz, assuming that the front is covered with shielded front panels, testing in accordance with VG 95373 part 15

Supplied as space-saving flat-pack

IP 20, in accordance with IEC 60529

Horizontal rail type "Heavy"

## PRODUCT ATTRIBUTES

---

Rack Height: 6U

Depth (D): 275mm

Rear I/O: Yes

Package Quantity: 1

For Mounting: Backplane

Board Depth: 80mm; 160mm

Gasket Type: Textile EMC

Handle Included: No

Mounting: Rack

Complies With: IEC 60297-3-103; IEEE 1101.10; IEEE 1101.11

EMC Shielding: Yes

Finish: Anodized; Passivated

Material: Aluminum

Product Type: Subrack/Chassis

Rack Width: 84HP

Static Load: 11kg

Net Weight: 3.42kg

## ADDITIONAL PRODUCT DETAILS

---

Individual configuration: broad range of variants in height, width and depth; guide rails for a wide variety of applications; interior options; accessories and mounting material.

## DIAGRAMS

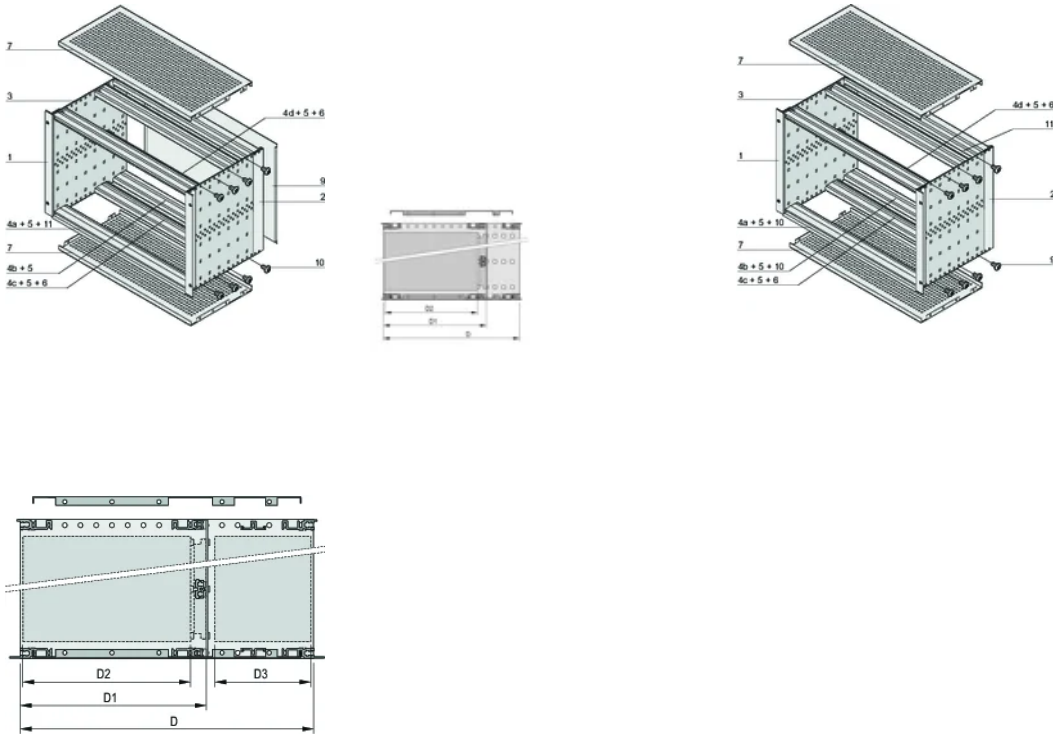

## WARNING

nVent products shall be installed and used only as indicated in nVent's product instruction sheets and training materials. Instruction sheets are available at [www.nvent.com](http://www.nvent.com) and from your nVent customer service representative. Improper installation, misuse, misapplication or other failure to completely follow nVent's instructions and warnings may cause product malfunction, property damage, serious bodily injury and death and/or void your warranty.

### North America

All locations  
+1.763.422.2661  
Chat with us:  
[nvent.com/schroff](http://nvent.com/schroff)

### Europe

Straubenhardt, Germany  
+49.7082.794.0  
Betschdorf, France  
+33.3.88.90.64.90  
Warsaw, Poland  
+48.22.209.98.35  
Assago, Italy  
+39.02.932.7141  
Chat with us:  
[nvent.com/schroff](http://nvent.com/schroff)

### Asia

Shanghai, China  
+86.21.2412.6943  
Qingdao, China  
+86.532.8771.6101  
Singapore  
+65.6768.5800  
Shin-Yokohama, Japan  
+81.45.476.0271  
Chat with us:  
[nvent.com/schroff](http://nvent.com/schroff)

### Middle East & India

Dubai, United Arab Emirates  
+971.4.378.1700  
Bangalore, India  
+91.80.6715.2001  
Istanbul, Turkey  
+90.216.250.7374  
Chat with us:  
[nvent.com/schroff](http://nvent.com/schroff)



Our powerful portfolio of brands:

**CADDY ERICO HOFFMAN ILSCO SCHROFF TRACHTE**