

Front Frame, Unshielded for Horizontal Boards Mounting, 4 U, 28 HP

CATALOG NUMBER

34564-208

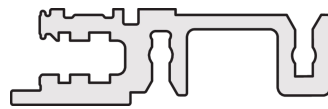
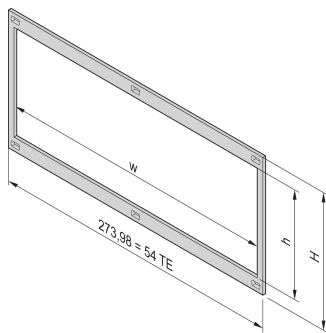

Front frame installation provides the contact between subracks and assemblies. It must be used if a customer has selected a horizontal board mounting Kit.

CERTIFICATIONS



FEATURES

Front frame, Unshielded, for horizontal board mounting

PRODUCT ATTRIBUTES

Rack Height: 4U

Rack Width: 28HP

Package Quantity: 1

Finish: Anodized

Material: Aluminum

Product Family: EuropacPRO

Product Type: Side Panel

WARNING

nVent products shall be installed and used only as indicated in nVent's product instruction sheets and training materials. Instruction sheets are available at www.nvent.com and from your nVent customer service representative. Improper installation, misuse, misapplication or other failure to completely follow nVent's instructions and warnings may cause product malfunction, property damage, serious bodily injury and death and/or void your warranty.

North America

All locations
+1.763.422.2661
Chat with us:
nvent.com/schroff

Europe

Straubenhardt, Germany
+49.7082.794.0
Betschdorf, France
+33.3.88.90.64.90
Warsaw, Poland
+48.22.209.98.35
Assago, Italy
+39.02.932.7141
Chat with us:
nvent.com/schroff

Asia

Shanghai, China
+86.21.2412.6943
Qingdao, China
+86.532.8771.6101
Singapore
+65.6768.5800
Shin-Yokohama, Japan
+81.45.476.0271
Chat with us:
nvent.com/schroff

Middle East & India

Dubai, United Arab
Emirates
+971.4.378.1700
Bangalore, India
+91.80.6715.2001
Istanbul, Turkey
+90.216.250.7374
Chat with us:
nvent.com/schroff



Our powerful portfolio of brands:

CADDY ERICO HOFFMAN ILSCO SCHROFF TRACHTE