

# Guide Rail Accessory Type, Strengthened, PC, 220 mm, 2 mm Groove Width, Red

## CATALOG NUMBER

**64568-078**

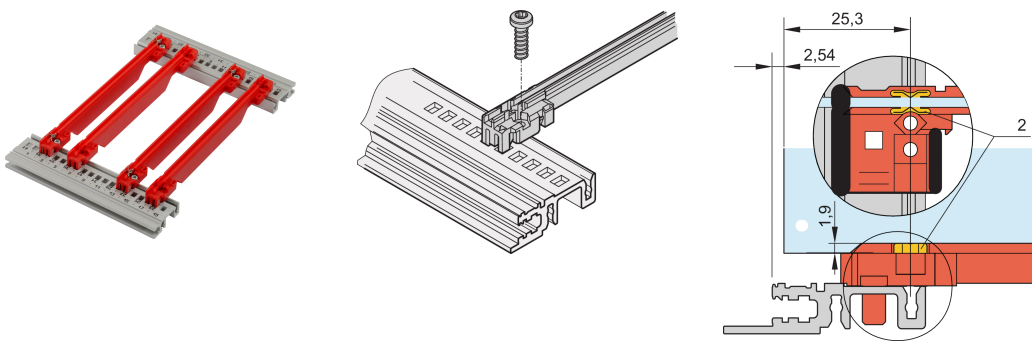

New generation of Strengthened Accessory type guide rails for PCBs or plug-in units. Forms a reliable interface between the subrack mechanics and the sub-assemblies. With the optimized design and the new high quality plastic material not just the stability was significantly increased, but also the fire safety properties improved. Which means the material ensures a low flammability, low smoke toxicity and density and fulfills the EN 45545-2 (Fire Safety in Railway Vehicle) requirements sets R22, R23 and R24 with the highest hazard level HL3. In addition the guide rails are also considered as "Halogen-Free", according to IEC 61249-2-21.

## CERTIFICATIONS



## FEATURES

NEW generation Strengthened Accessory type plastic guide rails for reliable retention of PCBs or plug-in units

Significantly increased stability, due to a high quality material (PC) and an optimized design, which also allows now the usage with rugged horizontal rails

Improved fire safety properties, fulfills EN 45545-2 requirement sets R22, R23 and R24 with HL3

"Halogen-Free", according to IEC 61249-2-21

Can be clipped into horizontal rails (Al extrusion) or into 1.5 mm thick plates

Can be bolted to the horizontal rails Type H and R for higher shock and vibration requirements

Optional ESD clip for an conductive contact between PCB and horizontal rail available

Storage temperature: from -40 °C ... 130 °C

## PRODUCT ATTRIBUTES

Package Quantity: 1

Board Depth: 220mm

Groove Width: 2

Color: Red

Complies With: EN 45545-2

Material: Fiber-Reinforced Plastic

Product Family: EuropacPRO; RatiopacPRO; RatiopacPRO AIR; CompacPRO; PropacPRO; MultipacPRO; Inpac

Product Type: Guide Rail

Type: Strengthened

Works With: Subracks; Cases; 19" Chassis; Systems

Net Weight: 0.014kg

## ADDITIONAL PRODUCT DETAILS

Please take into consideration that deliveries may be carried out in the stated SPQs (SPQ, e.g. 5 pieces, 10 pieces, 50 pieces, etc.). Differing order quantities (e.g. 2 pieces) may be changed to the next possible delivery quantity = Standard Pack Quantity.

## WARNING

nVent products shall be installed and used only as indicated in nVent's product instruction sheets and training materials. Instruction sheets are available at [www.nvent.com](http://www.nvent.com) and from your nVent customer service representative. Improper installation, misuse, misapplication or other failure to completely follow nVent's instructions and warnings may cause product malfunction, property damage, serious bodily injury and death and/or void your warranty.

### North America

All locations  
+1.763.422.2661  
Chat with us:  
[nvent.com/schroff](http://nvent.com/schroff)

### Europe

Straubenhardt, Germany  
+49.7082.794.0  
Betschdorf, France  
+33.3.88.90.64.90  
Warsaw, Poland  
+48.22.209.98.35  
Assago, Italy  
+39.02.932.7141  
Chat with us:  
[nvent.com/schroff](http://nvent.com/schroff)

### Asia

Shanghai, China  
+86.21.2412.6943  
Qingdao, China  
+86.532.8771.6101  
Singapore  
+65.6768.5800  
Shin-Yokohama, Japan  
+81.45.476.0271  
Chat with us:  
[nvent.com/schroff](http://nvent.com/schroff)

### Middle East & India

Dubai, United Arab  
Emirates  
+971.4.378.1700  
Bangalore, India  
+91.80.6715.2001  
Istanbul, Turkey  
+90.216.250.7374  
Chat with us:  
[nvent.com/schroff](http://nvent.com/schroff)



Our powerful portfolio of brands:

**CADDY ERICO HOFFMAN ILSCO SCHROFF TRACHTE**