

Low Voltage Male/Female Insulators, 50 mm

Data Solutions

CATALOG NUMBER

ISOTP50F8M8



CERTIFICATIONS



FEATURES

Halogen free

High resistance to leakage current

Great stability of electrical and mechanical parameters

Fiberglass reinforced

UL® Recognized in E125470 and evaluated for dielectric withstand rating of 1,500 VAC/DC

RoHS compliant

PRODUCT ATTRIBUTES

Article Number: 542070

Material: Steel; Glass Fibre Reinforced Polyamide

Finish: Electrogalvanized

Working Temperature: -40 to 130°C

Insulation Voltage: 1000; 1500

Flammability Rating: UL® 94V-0

Complies With: IEC® 60695-2-11 (Glow Wire Test 960 °C)

Height (H): 50mm

Hex Width (W): 50mm

Depth (D): 57mm

Diameter (Ø): 41mm

Thread Size 1 (TS1): M8

Thread Length (TL): 17mm

Thread Size 2 (TS2): M8

Thread Depth (TD): 15mm

Static Load 1 (F1): 20000daN

Static Load 2 (F2): 10000daN

Unit Weight: 0.15kg

DIAGRAMS

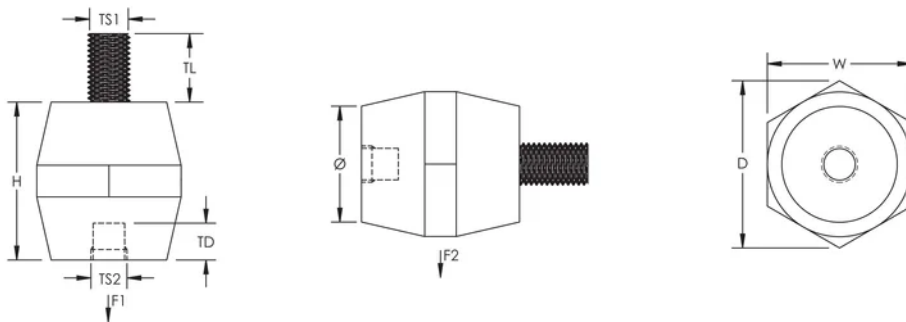

WARNING

nVent products shall be installed and used only as indicated in nVent's product instruction sheets and training materials. Instruction sheets are available at www.nvent.com and from your nVent customer service representative. Improper installation, misuse, misapplication or other failure to completely follow nVent's instructions and warnings may cause product malfunction, property damage, serious bodily injury and death and/or void your warranty.



Our powerful portfolio of brands:

CADDY ERICO HOFFMAN ILSCO SCHROFF TRACHTE