

EMC Shielding Kit, Between Horizontal Rails, Stainless Steel, 42 HP

CATALOG NUMBER

24562-542

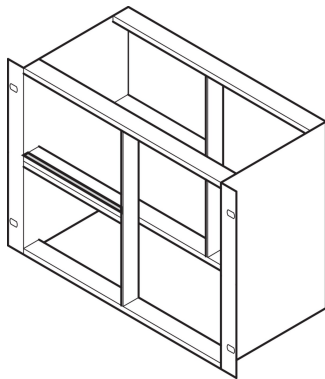
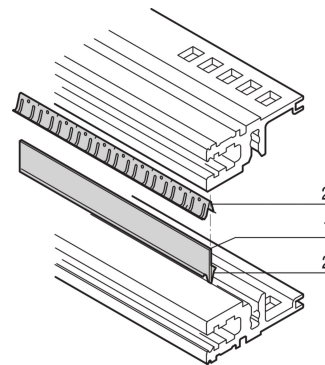

The contact strip makes contact between horizontal rails. If two horizontal rails are mounted one above the other, the seals plus a metal strip enable EMC shielding.

CERTIFICATIONS



FEATURES

If two horizontal rails are mounted one above the other, the seals plus a metal strip enable EMC shielding

PRODUCT ATTRIBUTES

Rack Width: 42HP

Package Quantity: 1

Length: 218mm

Material: Stainless Steel; Aluminum

Product Family: EuropacPRO

Product Type: Shielding Kit

Works With: Subracks

Net Weight: 0.03kg

WARNING

nVent products shall be installed and used only as indicated in nVent's product instruction sheets and training materials. Instruction sheets are available at www.nvent.com and from your nVent customer service representative. Improper installation, misuse, misapplication or other failure to completely follow nVent's instructions and warnings may cause product malfunction, property damage, serious bodily injury and death and/or void your warranty.

North America

All locations
+1.763.422.2661
Chat with us:
nvent.com/schroff

Europe

Straubenhardt, Germany
+49.7082.794.0
Betschdorf, France
+33.3.88.90.64.90
Warsaw, Poland
+48.22.209.98.35
Assago, Italy
+39.02.932.7141
Chat with us:
nvent.com/schroff

Asia

Shanghai, China
+86.21.2412.6943
Qingdao, China
+86.532.8771.6101
Singapore
+65.6768.5800
Shin-Yokohama, Japan
+81.45.476.0271
Chat with us:
nvent.com/schroff

Middle East & India

Dubai, United Arab Emirates
+971.4.378.1700
Bangalore, India
+91.80.6715.2001
Istanbul, Turkey
+90.216.250.7374
Chat with us:
nvent.com/schroff



Our powerful portfolio of brands:

CADDY ERICO HOFFMAN ILSCO SCHROFF TRACHTE