

Varistar CP | Depth Member, 3 rows, 600D, Aluzinc

Data Solutions

CATALOG NUMBER

23130-081

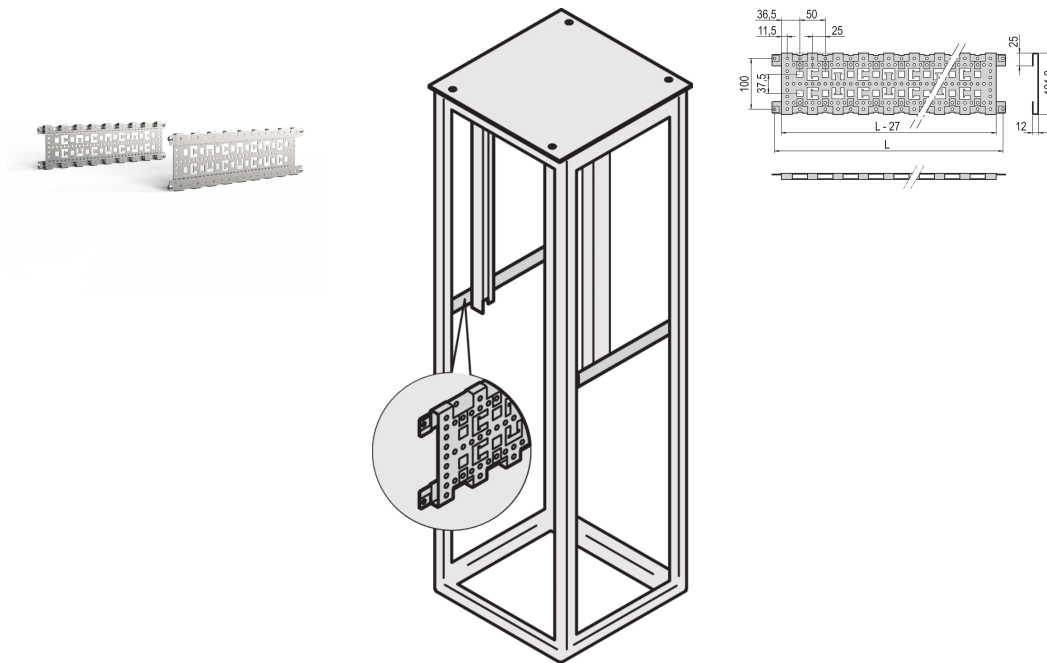

Horizontal depth member in the cabinet depth. Mounted directly at the Varistar CP frame for cable management, increased frame stiffness and additional fixing points.

CERTIFICATIONS



FEATURES

Cable routing facilitated using cable ties and cable eyes, required for recessed shelf

St, 1.5 mm, finish AlZn

PRODUCT ATTRIBUTES

Depth: 600mm

Package Quantity: 2

Finish: Aluminum-Zinc Plated

Height: 135mm

Material: Steel

Product Family: Varistar CP

Product Type: Bracket

Rack Height: 3U

Works With: Varistar CP

Package Unit: Pair

Net Weight: 1.55kg

WARNING

nVent products shall be installed and used only as indicated in nVent's product instruction sheets and training materials. Instruction sheets are available at www.nvent.com and from your nVent customer service representative. Improper installation, misuse, misapplication or other failure to completely follow nVent's instructions and warnings may cause product malfunction, property damage, serious bodily injury and death and/or void your warranty.



Our powerful portfolio of brands:

CADDY ERICO HOFFMAN ILSCO SCHROFF TRACHTE