

EuropacPRO Divider Plate, 3 U, 160 mm

CATALOG NUMBER

34562-761

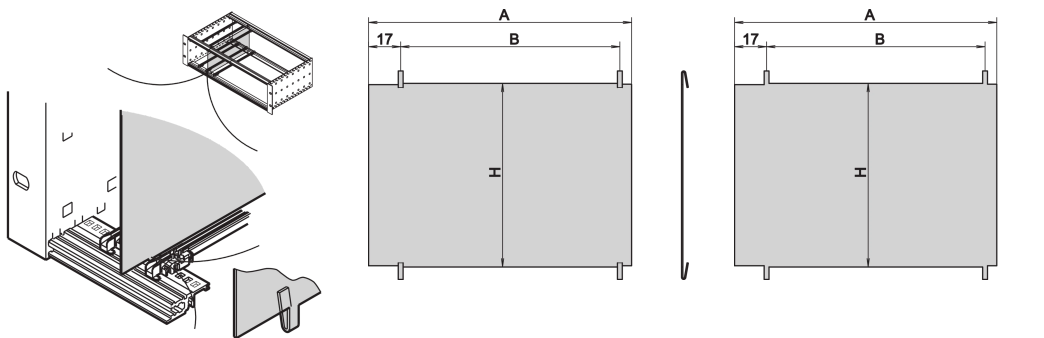

The divider plate enables the user to create a separate area inside a subrack or case. The plate can be clipped into the perforation of the horizontal rails. The subracks or cases have to be disassembled if the plate will be assembled.

CERTIFICATIONS



FEATURES

Mounts by clipping into horizontal rails

Space requirement on component side: 2.0 mm

Fitting depends on gasketing method (stainless steel/textile gasket)

PRODUCT ATTRIBUTES

Rack Height: 3U

Package Quantity: 1

Depth: 160mm

Length: 160mm

Material: Stainless Steel

Product Family: EuropacPRO

Product Type: Side Panel

Works With: Subracks

Net Weight: 0.128kg

ADDITIONAL PRODUCT DETAILS

Subsequent installation of the divider plate in a mounted subrack requires removal of the horizontal rails beforehand.

WARNING

nVent products shall be installed and used only as indicated in nVent's product instruction sheets and training materials. Instruction sheets are available at www.nvent.com and from your nVent customer service representative. Improper installation, misuse, misapplication or other failure to completely follow nVent's instructions and warnings may cause product malfunction, property damage, serious bodily injury and death and/or void your warranty.

North America

All locations
+1.763.422.2661
Chat with us:
nvent.com/schroff

Europe

Straubenhardt, Germany
+49.7082.794.0
Betschdorf, France
+33.3.88.90.64.90
Warsaw, Poland
+48.22.209.98.35
Assago, Italy
+39.02.932.7141
Chat with us:
nvent.com/schroff

Asia

Shanghai, China
+86.21.2412.6943
Qingdao, China
+86.532.8771.6101
Singapore
+65.6768.5800
Shin-Yokohama, Japan
+81.45.476.0271
Chat with us:
nvent.com/schroff

Middle East & India

Dubai, United Arab
Emirates
+971.4.378.1700
Bangalore, India
+91.80.6715.2001
Istanbul, Turkey
+90.216.250.7374
Chat with us:
nvent.com/schroff



Our powerful portfolio of brands:

CADDY ERICO HOFFMAN ILSCO SCHROFF TRACHTE