

# nVent CADDY Macrofix Plus Kombi with Combination Nut, M8, M10, 1/2" Rod, 138-148mm OD

## CATALOG NUMBER

**MPK148**



## FEATURES

Includes easy closing mechanism

Age-resistant lining

Category II noise reduction according to DIN EN ISO 3822-1

Compliant for sound insulation design according to DIN 4109

Reaction-to-fire classification is "E" in compliance with DIN EN 13501-1

## PRODUCT ATTRIBUTES

Article Number: 586765

Rod Size (RS): M8;M10;1/2"

Temperature: -50 to 110 °C

Color: Black

Material: Steel;EPDM-SBR Rubber

Finish: Electrogalvanized

Outer Diameter (OD): 138 - 148 mm

Pipe Size: 5"

NB/DN: 125

Width (W): 25 mm

Thickness (T): 2 mm

Screw Diameter (Sc): 6 mm

Screw Length (L): 50mm

Static Load: 3200N

Unit Weight: 0.4 kg

## ADDITIONAL PRODUCT DETAILS

Lining is EPDM rubber.

## DIAGRAMS

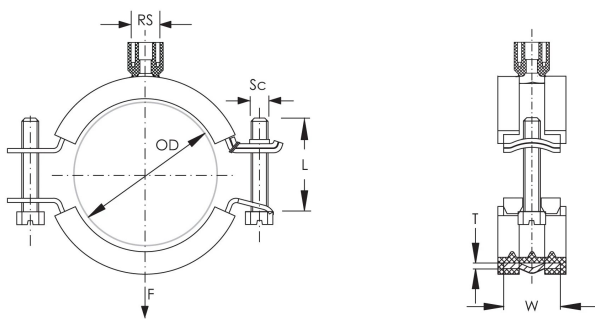

## WARNING

nVent products shall be installed and used only as indicated in nVent's product instruction sheets and training materials. Instruction sheets are available at [www.nvent.com](http://www.nvent.com) and from your nVent customer service representative. Improper installation, misuse, misapplication or other failure to completely follow nVent's instructions and warnings may cause product malfunction, property damage, serious bodily injury and death and/or void your warranty.

### North America

+1.800.753.9221

Option 1 – Customer Care

Option 2 – Technical

Support

### Europe

Netherlands:

+31 800-0200135

France:

+33 800 901 793

### Europe

Germany:

800 1890272

Other Countries:

+31 13 5835404

### APAC

Shanghai:

+ 86 21 2412 1618/19

Sydney:

+61 2 9751 8500



Our powerful portfolio of brands:

CADDY

ERICO

HOFFMAN

ILSCO

SCHROFF

TRACHTE

