

# Heavy-Duty Pipe Clamp 66-73mm, M10/M12, Geomet

## CATALOG NUMBER

**HDN060G**



## FEATURES

Fillet welded connector nut has flats to accommodate spanners

## PRODUCT ATTRIBUTES

Article Number: 579128

Nut Included: Yes

Material: Steel

Finish: GEOMET® 321

Outer Diameter (OD): 66 - 73 mm

Rod Size (RS): M8;M10

Width (W): 25 mm

Thickness (T): 2 mm

Screw Diameter (Sc): 8 mm

Screw Diameter metric (Sc): M8

Screw Length (L): 25mm

Static Load: 3500N

## DIAGRAMS

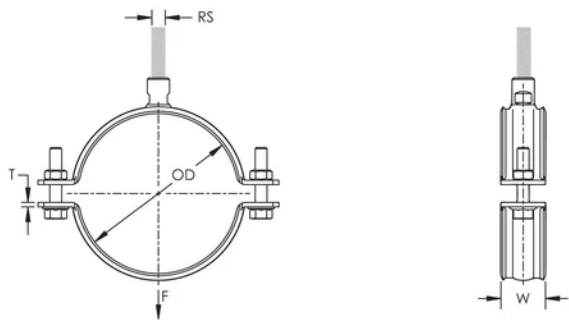

## WARNING

nVent products shall be installed and used only as indicated in nVent's product instruction sheets and training materials. Instruction sheets are available at [www.nvent.com](http://www.nvent.com) and from your nVent customer service representative. Improper installation, misuse, misapplication or other failure to completely follow nVent's instructions and warnings may cause product malfunction, property damage, serious bodily injury and death and/or void your warranty.

### North America

+1.800.753.9221  
Option 1 – Customer Care  
Option 2 – Technical  
Support

### Europe

Netherlands:  
+31 800-0200135  
France:  
+33 800 901 793

### Europe

Germany:  
800 1890272  
Other Countries:  
+31 13 5835404

### APAC

Shanghai:  
+ 86 21 2412 1618/19  
Sydney:  
+61 2 9751 8500



Our powerful portfolio of brands:

**CADDY ERICO HOFFMAN ILSCO SCHROFF TRACHTE**

