

Cage Nut Kit, M6, 50 pcs

Data Solutions

CATALOG NUMBER

21100-003

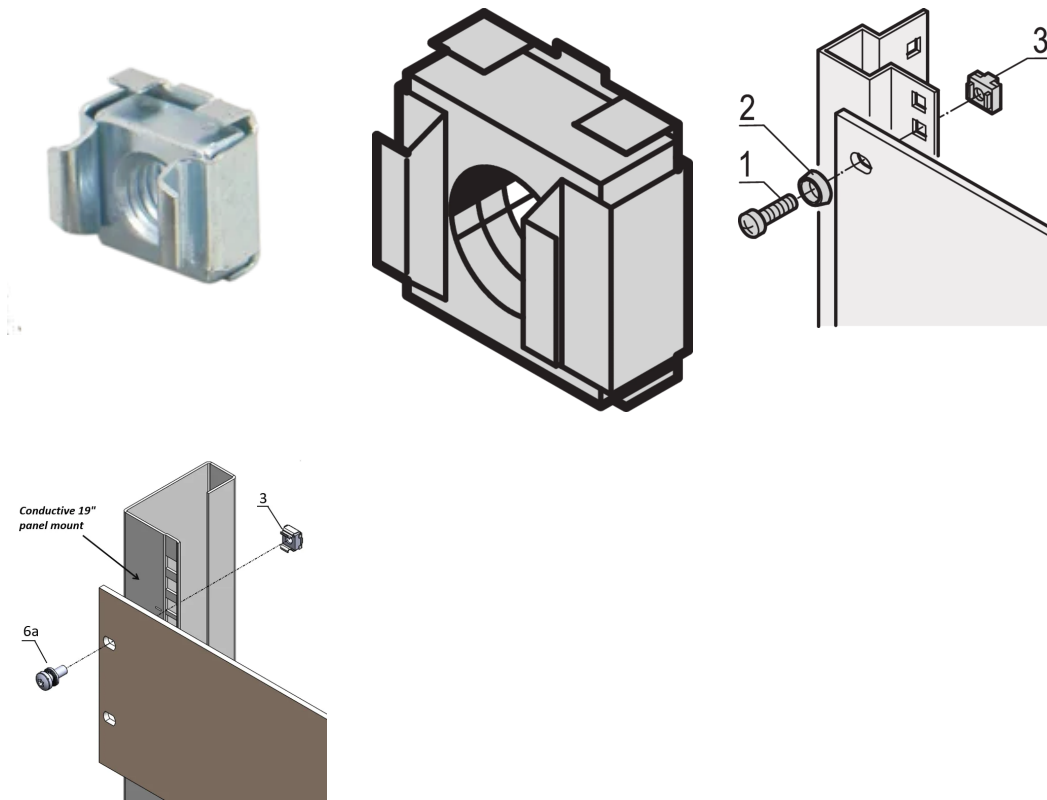

Cage nuts permit range of choice of nut and bolts sizes and easily replaced unlike pre-threaded holes. Cage nuts are easy to use on materials too thin or soft to be threaded.

CERTIFICATIONS



FEATURES

For assembly of parts which require a thread size of M4 or M5

For standard grounding use a grounding nut and washer on at least one attachment point

PRODUCT ATTRIBUTES

Finish: Zinc Plated

Package Quantity: 50

Thread Size: M6

Material: Steel

Product Family: RatiopacPRO; RatiopacPRO AIR; CompacPRO; PropacPRO; Comptec; Inpac; MultipacPRO

Product Type: Nut

Type: Cage Nut

Works With: Front Panels; Eurorack; Novastar; Varistar; Varistar CP

Net Weight: 0.23kg

WARNING

nVent products shall be installed and used only as indicated in nVent's product instruction sheets and training materials. Instruction sheets are available at www.nvent.com and from your nVent customer service representative. Improper installation, misuse, misapplication or other failure to completely follow nVent's instructions and warnings may cause product malfunction, property damage, serious bodily injury and death and/or void your warranty.



Our powerful portfolio of brands:

CADDY ERICO HOFFMAN ILSCO SCHROFF TRACHTE