

Panhead Screw, Pozidriv, Cross Recess M2.5 x 8, Steel Nickel Plated, 100 pieces

Data Solutions

CATALOG NUMBER

21101-069

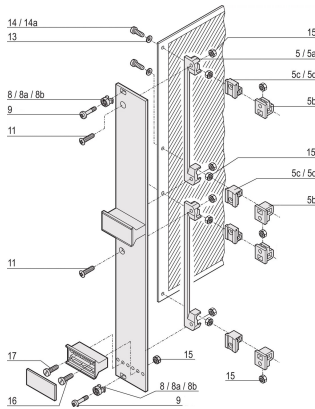
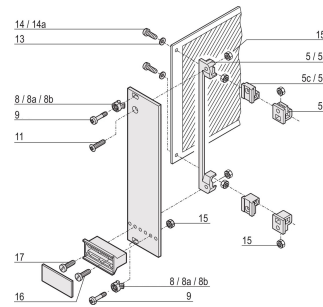
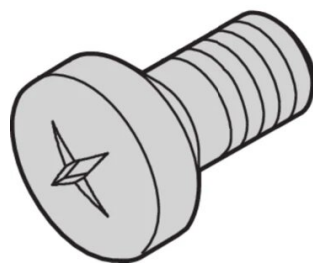

Panhead Screw, Pozidrive.

CERTIFICATIONS



FEATURES

Panhead screw, pozidrive

PRODUCT ATTRIBUTES

Length: 8mm

Finish: Nickel Plated

Package Quantity: 100

Thread Size: M2.5

Material: Steel

Product Family: Frame Type Plug-In Unit

Product Type: Screw

Type: Panhead Screw

Works With: Backplanes; Test Adapters

Net Weight: 0.048kg

WARNING

nVent products shall be installed and used only as indicated in nVent's product instruction sheets and training materials. Instruction sheets are available at www.nvent.com and from your nVent customer service representative. Improper installation, misuse, misapplication or other failure to completely follow nVent's instructions and warnings may cause product malfunction, property damage, serious bodily injury and death and/or void your warranty.



Our powerful portfolio of brands:

CADDY ERICO HOFFMAN ILSCO SCHROFF TRACHTE