

# C-Rail Cable Shell, for Cable Bundle 22 ... 26 mm

## Data Solutions

### CATALOG NUMBER

**20118-776**

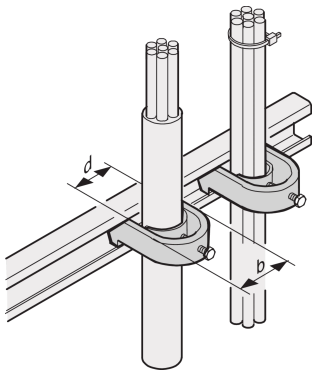

C-Rails are for better cable management. Installation generally behind the 19" uprights. They are compatible with standard cable clabs.

### CERTIFICATIONS



### FEATURES

For mounting of cables on C-profiles and cable support rails

### PRODUCT ATTRIBUTES

Finish: Tin Plated

Package Quantity: 10

Material: Steel

Product Family: Varistar CP

Product Type: Clamp

Type: Cable Clamp

Net Weight: 0.42kg

## WARNING

---

nVent products shall be installed and used only as indicated in nVent's product instruction sheets and training materials. Instruction sheets are available at [www.nvent.com](http://www.nvent.com) and from your nVent customer service representative. Improper installation, misuse, misapplication or other failure to completely follow nVent's instructions and warnings may cause product malfunction, property damage, serious bodily injury and death and/or void your warranty.



Our powerful portfolio of brands:

**CADDY   ERICO   HOFFMAN   ILSCO   SCHROFF   TRACHTE**