

Stacking Aid Kit for RatiopacPRO/-Air Case or Interscale, RAL 7016

CATALOG NUMBER

20603-003

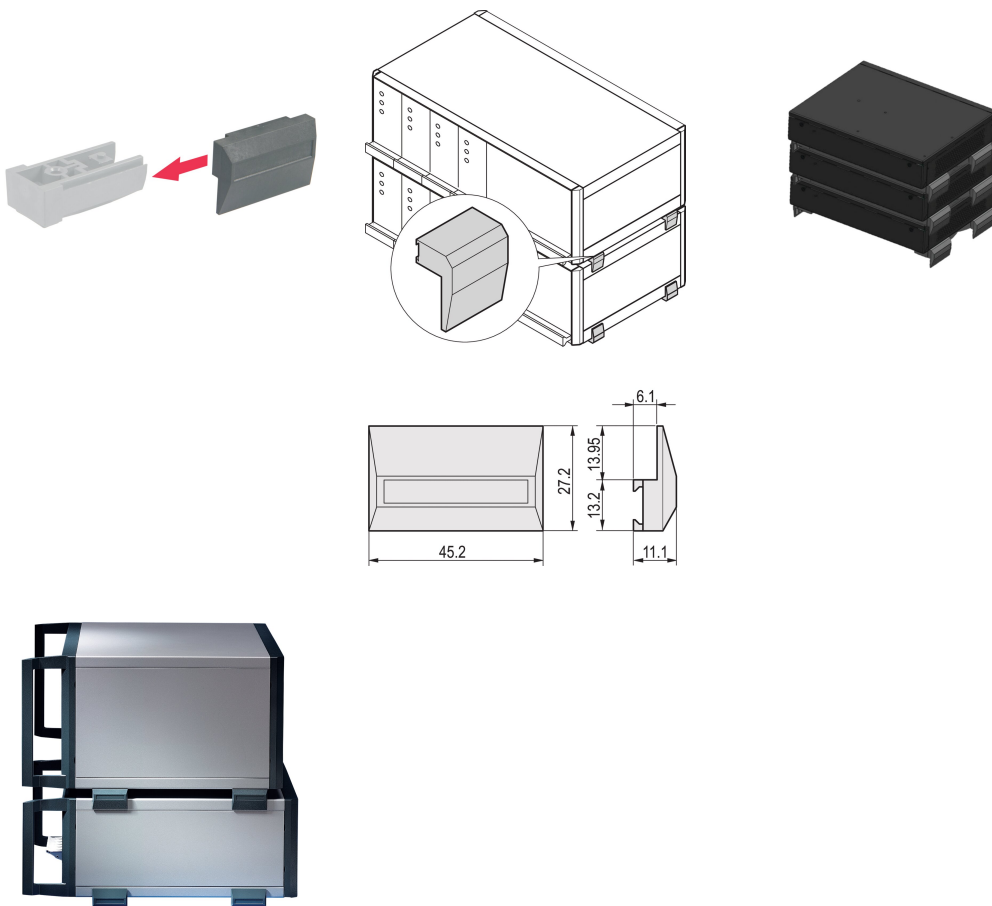

Stacking aid is clipped onto tip-up foot to guarantee protection during stacking of cases.

CERTIFICATIONS



FEATURES

Stacking aid is clipped onto tip-up foot

Stacking Aid Kit for RatiopacPRO/-Air Case or Interscale

PRODUCT ATTRIBUTES

Package Quantity: 4

Material: Polyamide 66

Product Family: RatiopacPRO; RatiopacPRO AIR

Product Type: Hardware Kit

Works With: Cases

Net Weight: 0.03kg

ADDITIONAL PRODUCT DETAILS

Please order tip-up foot kit separately.

WARNING

nVent products shall be installed and used only as indicated in nVent's product instruction sheets and training materials. Instruction sheets are available at www.nvent.com and from your nVent customer service representative. Improper installation, misuse, misapplication or other failure to completely follow nVent's instructions and warnings may cause product malfunction, property damage, serious bodily injury and death and/or void your warranty.

North America

All locations
+1.763.422.2661
Chat with us:
nvent.com/schroff

Europe

Straubenhardt, Germany
+49.7082.794.0
Betschdorf, France
+33.3.88.90.64.90
Warsaw, Poland
+48.22.209.98.35
Assago, Italy
+39.02.932.7141
Chat with us:
nvent.com/schroff

Asia

Shanghai, China
+86.21.2412.6943
Qingdao, China
+86.532.8771.6101
Singapore
+65.6768.5800
Shin-Yokohama, Japan
+81.45.476.0271
Chat with us:
nvent.com/schroff

Middle East & India

Dubai, United Arab
Emirates
+971.4.378.1700
Bangalore, India
+91.80.6715.2001
Istanbul, Turkey
+90.216.250.7374
Chat with us:
nvent.com/schroff



Our powerful portfolio of brands:

CADDY ERICO HOFFMAN ILSCO SCHROFF TRACHTE