

# Varistar CP | C-Rail for Cabinet Depth 600 mm

## Data Solutions

### CATALOG NUMBER

**23130-086**

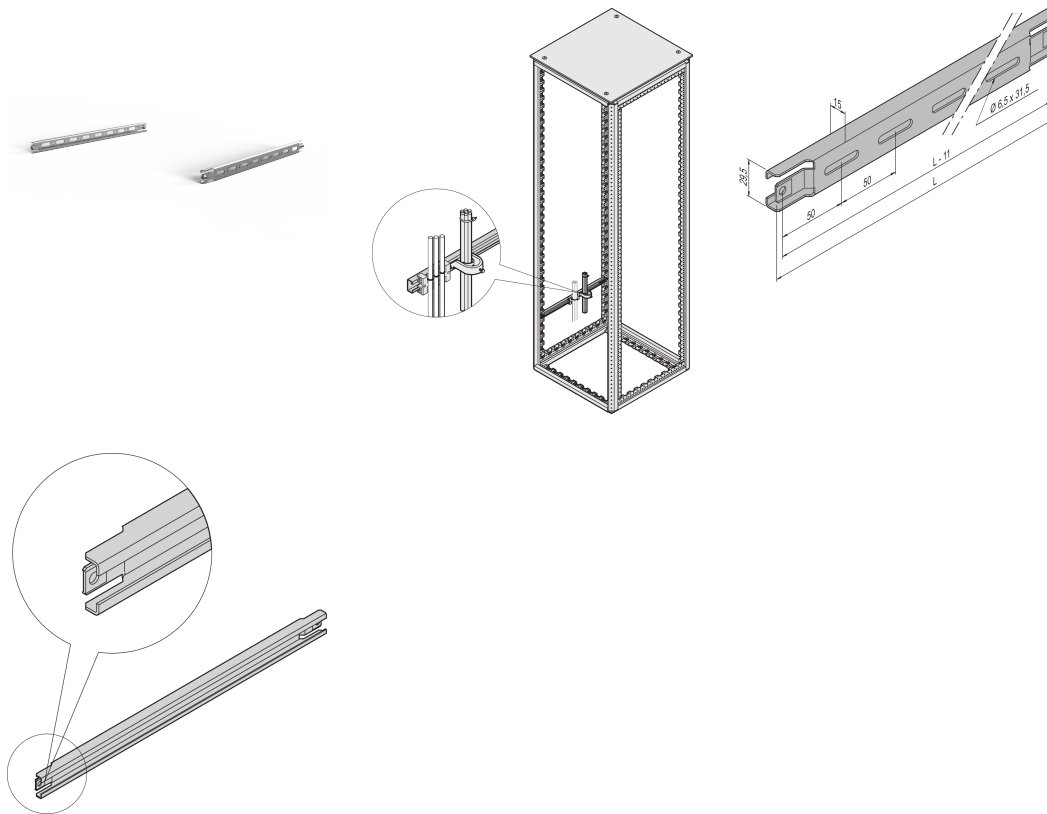

For cable ducting in side area of cabinet.

### CERTIFICATIONS



### FEATURES

For cable ducting in side area of cabinet

For cable shells and cable retention rails

## PRODUCT ATTRIBUTES

---

Depth: 600mm

Package Quantity: 2

Finish: Aluminum-Zinc Plated

Length: 460mm

Material: Steel

Product Family: Varistar CP

Product Type: C-Rail

Gross Weight: 0.73kg

## WARNING

---

nVent products shall be installed and used only as indicated in nVent's product instruction sheets and training materials. Instruction sheets are available at [www.nvent.com](http://www.nvent.com) and from your nVent customer service representative. Improper installation, misuse, misapplication or other failure to completely follow nVent's instructions and warnings may cause product malfunction, property damage, serious bodily injury and death and/or void your warranty.



Our powerful portfolio of brands:

**CADDY ERICO HOFFMAN ILSCO SCHROFF TRACHTE**