

Varistar CP | C-Rail for Cabinet Depth 900 mm

Data Solutions

CATALOG NUMBER

23130-088

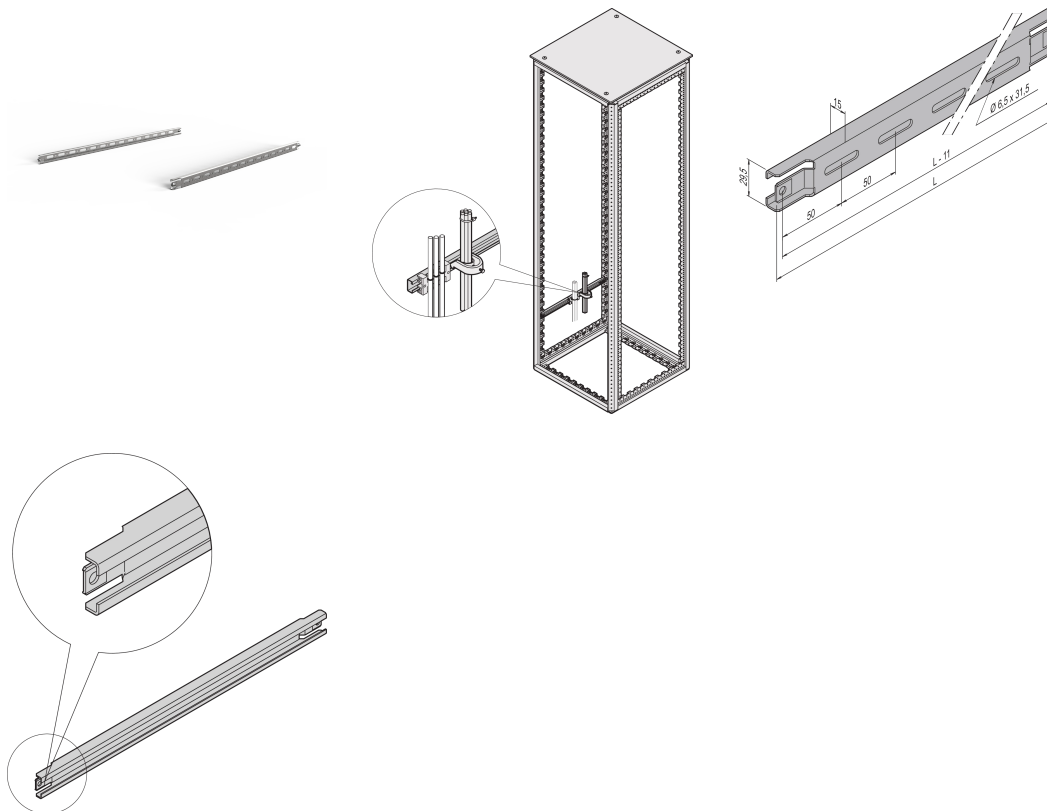

For cable ducting in side area of cabinet.

CERTIFICATIONS



FEATURES

For cable ducting in side area of cabinet

For cable shells and cable retention rails

PRODUCT ATTRIBUTES

Depth: 900mm

Package Quantity: 2

Finish: Aluminum-Zinc Plated

Length: 760mm

Material: Steel

Product Family: Varistar CP

Product Type: C-Rail

Gross Weight: 1.24kg

WARNING

nVent products shall be installed and used only as indicated in nVent's product instruction sheets and training materials. Instruction sheets are available at www.nvent.com and from your nVent customer service representative. Improper installation, misuse, misapplication or other failure to completely follow nVent's instructions and warnings may cause product malfunction, property damage, serious bodily injury and death and/or void your warranty.



Our powerful portfolio of brands:

CADDY ERICO HOFFMAN ILSCO SCHROFF TRACHTE