

RatiopacPro Tip-Up Handle Assembly Kit, 3 U, 315 mm

CATALOG NUMBER

24571-353

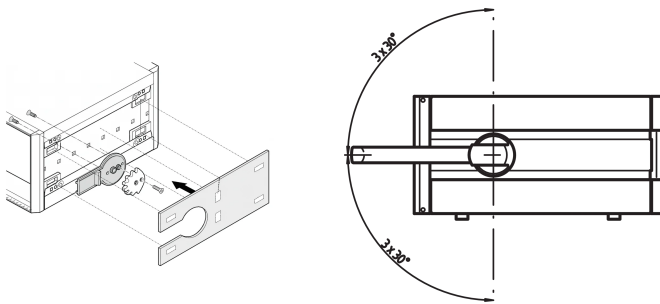

The assembly kit must be used if a tip-up handle should be mounted. Standard side covers should be replaced.

CERTIFICATIONS



FEATURES

Aluminum side panel powder coated RAL 9006, Adapter and assembly material.

PRODUCT ATTRIBUTES

Rack Height: 3U

Rack Width: 42HP

Depth: 315mm

Package Quantity: 2

Finish: Powder Coated

Material: Aluminum

Product Family: RatiopacPRO; RatiopacPRO AIR

Product Type: Assembly Kit

Type: Tip-Up Handle Kit

Works With: Cases

Gross Weight: 0.284kg

WARNING

nVent products shall be installed and used only as indicated in nVent's product instruction sheets and training materials. Instruction sheets are available at www.nvent.com and from your nVent customer service representative. Improper installation, misuse, misapplication or other failure to completely follow nVent's instructions and warnings may cause product malfunction, property damage, serious bodily injury and death and/or void your warranty.

North America

All locations
+1.763.422.2661
Chat with us:
nvent.com/schroff

Europe

Straubenhardt, Germany
+49.7082.794.0
Betschdorf, France
+33.3.88.90.64.90
Warsaw, Poland
+48.22.209.98.35
Assago, Italy
+39.02.932.7141
Chat with us:
nvent.com/schroff

Asia

Shanghai, China
+86.21.2412.6943
Qingdao, China
+86.532.8771.6101
Singapore
+65.6768.5800
Shin-Yokohama, Japan
+81.45.476.0271
Chat with us:
nvent.com/schroff

Middle East & India

Dubai, United Arab
Emirates
+971.4.378.1700
Bangalore, India
+91.80.6715.2001
Istanbul, Turkey
+90.216.250.7374
Chat with us:
nvent.com/schroff



Our powerful portfolio of brands:

CADDY ERICO HOFFMAN ILSCO SCHROFF TRACHTE