

Heavy-Duty Pipe Clamp 317-333mm, 12" Pipe, DN 300, M20, Geomet

CATALOG NUMBER

HDN300G



FEATURES

Fillet welded connector nut has flats to accommodate spanners

PRODUCT ATTRIBUTES

Article Number: 579146

Nut Included: Yes

Material: Steel

Finish: GEOMET® 321

Outer Diameter (OD): 317 - 333 mm

Pipe Size: 12"

NB/DN: 300

Rod Size (RS): M20

Width (W): 50 mm

Thickness (T): 5 mm

Screw Diameter (Sc): 16 mm

Screw Diameter metric (Sc): M16

Screw Length (L): 60mm

Static Load: 12500N

DIAGRAMS

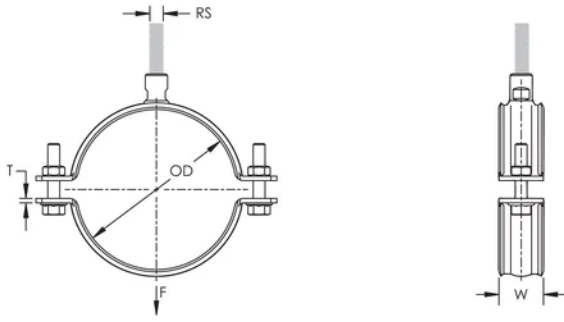

WARNING

nVent products shall be installed and used only as indicated in nVent's product instruction sheets and training materials. Instruction sheets are available at www.nvent.com and from your nVent customer service representative. Improper installation, misuse, misapplication or other failure to completely follow nVent's instructions and warnings may cause product malfunction, property damage, serious bodily injury and death and/or void your warranty.

North America

+1.800.753.9221
Option 1 – Customer Care
Option 2 – Technical
Support

Europe

Netherlands:
+31 800-0200135
France:
+33 800 901 793

Europe

Germany:
800 1890272
Other Countries:
+31 13 5835404

APAC

Shanghai:
+ 86 21 2412 1618/19
Sydney:
+61 2 9751 8500



Our powerful portfolio of brands:

CADDY ERICO HOFFMAN ILSCO SCHROFF TRACHTE

