

# nVent CADDY Cat HP J-Hook Tree, Wall Mount, 50 mm dia, 2 Tier

## Data Solutions

### CATALOG NUMBER

---

**CAT32HPSWM2**



### FEATURES

---

Ideal for attaching to concrete, steel or wood surfaces

Provides optimal support for high-performance data cable, up to and including Cat 5e, Cat 6, Cat 6A, Cat 7 and fibre optic

Ready to use out of the box, saving installation time and labor

Requires no screws, rivets or special tools for assembly

Provides superior fill capacity and load rating over most other non-continuous cable support alternatives

Complies with EN 50174-2

Meets ISO®/IEC 14763-2, ANSI®/TIA 568 and ANSI®/TIA 569

### PRODUCT ATTRIBUTES

---

Article Number: 181026

Material: Steel

Finish: Pregalvanized

Type: Single Sided

Diameter (Ø): 50mm

Tiers: 2

Height (H): 368.3mm

Width (W): 50mm

Hole Size (HS): 6.5mm

Static Load: 530N

Depth (D): 86.38mm

## ADDITIONAL PRODUCT DETAILS

---

Static loads represent maximum load limit of J-Hook tree. Static load limit of each J-Hook is 60 lb (270 N).

Non-continuous supports may not exceed spacing of 5' (1.5 m) per TIA 569-C.9.7 and EN 50174-2.

## DIAGRAMS

---

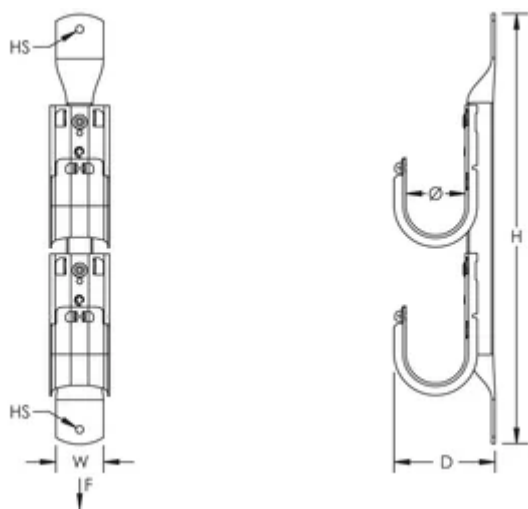

## WARNING

---

nVent products shall be installed and used only as indicated in nVent's product instruction sheets and training materials. Instruction sheets are available at [www.nvent.com](http://www.nvent.com) and from your nVent customer service representative. Improper installation, misuse, misapplication or other failure to completely follow nVent's instructions and warnings may cause product malfunction, property damage, serious bodily injury and death and/or void your warranty.



Our powerful portfolio of brands:

**CADDY   ERICO   HOFFMAN   ILSCO   SCHROFF   TRACHTE**