

Socket Strip, UTE, 15 Sockets

Data Solutions

CATALOG NUMBER

60110-223

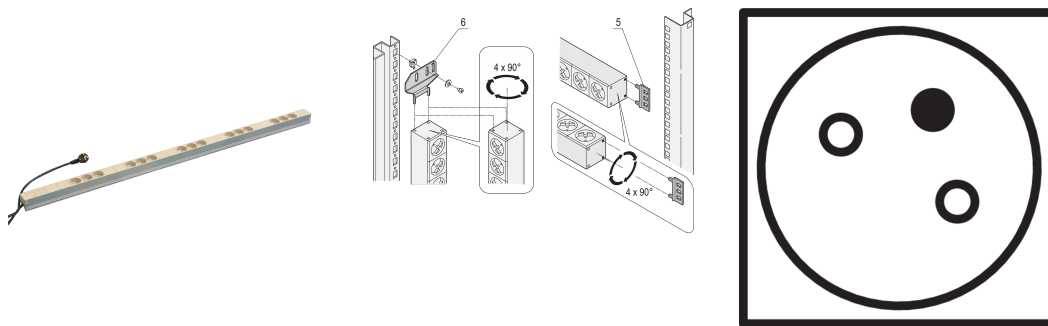

Modular, compact PDU with many function elements. Using a 1 U by 1 U aluminum chassis the PDU can easily be integrated in a rack with UTE outlets.

CERTIFICATIONS



FEATURES

230 V, 16 A

In accordance with NFC 61-303

Socket strip with UTE sockets

Mounting height 1 U

Horizontal or vertical mounting

Connecting cable 2 m, with SCHUKO/UTE plug

Socket strips can be rotated through all four directions (in 90° increments) during installation

PRODUCT ATTRIBUTES

Socket Type: UTE

Socket Quantity: 15

Switched Outlets: No

Voltage AC: 230V

Package Quantity: 1

Color: Grey

Depth: 44mm

Finish: Anodized

Length: 1202mm

Material: Aluminum; Polyamide

Product Type: Socket Strip

Net Weight: 1.97kg

ADDITIONAL PRODUCT DETAILS

Please order bracket for vertical mounting separately.

WARNING

nVent products shall be installed and used only as indicated in nVent's product instruction sheets and training materials. Instruction sheets are available at www.nvent.com and from your nVent customer service representative. Improper installation, misuse, misapplication or other failure to completely follow nVent's instructions and warnings may cause product malfunction, property damage, serious bodily injury and death and/or void your warranty.



Our powerful portfolio of brands:

CADDY ERICO HOFFMAN ILSCO SCHROFF TRACHTE