

Multi-Function Clip



CERTIFICATIONS



FEATURES

Provides attachment of electrical boxes

Supports #10-24 and 1/4-20 (M6) threaded bridle rings

Instills more confidence installing conduit, MC/AC, and low voltage applications

SPECIFICATIONS

Table 1/3

Catalog Number	Article Number	E-Number	Material	Finish	Rod Size (RS)	Wire Size
4Z34	170650	1500675	Spring Steel	nVent CADDY Armour	M4, M6, M8, M10	3.9 - 4.8 mm

Table 2/3

Catalog Number	Article Number	E-Number	Flange Thickness (FT)	Hole Size (HS)	Screw Included	Static Load 1 (F1)
4Z34	170650	1500675	3.0 - 9.5 mm	6.5 mm	No	110N

Table 3/3

Catalog Number	Article Number	E-Number	Static Load 2 (F2)
4Z34	170650	1500675	90N

ADDITIONAL PRODUCT DETAILS

NEC® 300.11 requires dedicated drop wire/rod and EC311.

4Z parts installed on 3/8" (M10) smooth rod in the F2 direction has a Static Load Rating of 15 lb (67 N).

DIAGRAMS

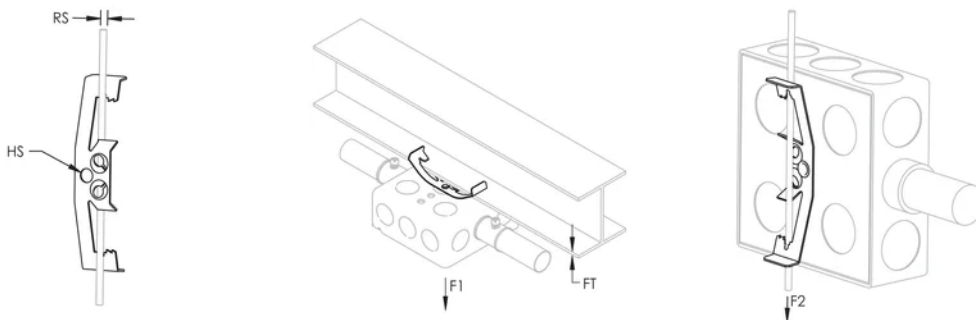

WARNING

nVent products shall be installed and used only as indicated in nVent's product instruction sheets and training materials. Instruction sheets are available at www.nvent.com and from your nVent customer service representative. Improper installation, misuse, misapplication or other failure to completely follow nVent's instructions and warnings may cause product malfunction, property damage, serious bodily injury and death and/or void your warranty.

North America

+1.800.753.9221
 Option 1 – Customer Care
 Option 2 – Technical
 Support

Europe

Netherlands:
 +31 800-0200135
 France:
 +33 800 901 793

Europe

Germany:
 800 1890272
 Other Countries:
 +31 13 5835404

APAC

Shanghai:
 + 86 21 2412 1618/19
 Sydney:
 +61 2 9751 8500



Our powerful portfolio of brands:

CADDY ERICO HOFFMAN ILSCO SCHROFF TRACHTE

