

19" Pusher Fan, 2 U, Axial, 230 VAC, Board Depth 160 mm, 445 - 530 m³h

CATALOG NUMBER

10713-534

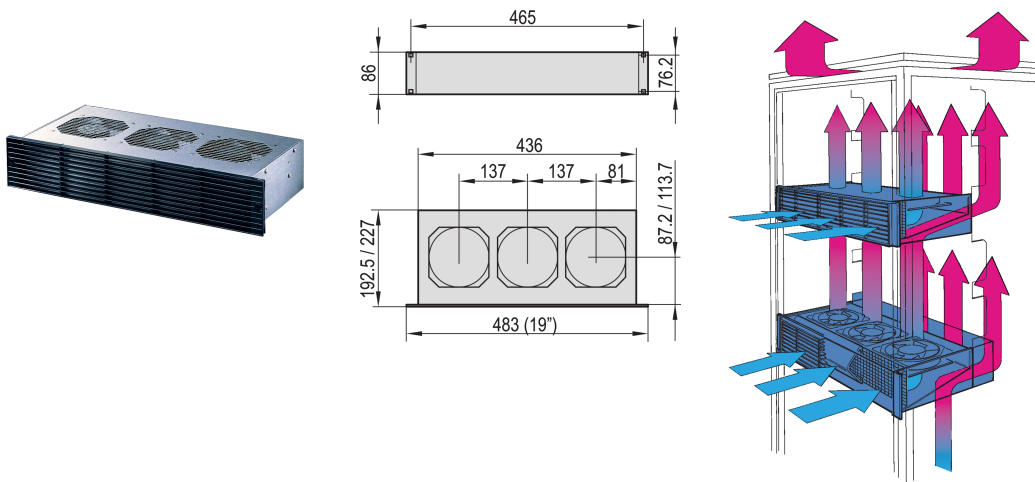

Fan tray with integrated pusher fan.

CERTIFICATIONS



FEATURES

Contact protection in accordance with DIN EN ISO 13857

Integrated air deflector prevents heat buildup in the assemblies mounted below

Can be adapted to subracks

Optionally with additional rear fan, 2 U, for active cooling of assemblies beneath the pusher fan

PRODUCT ATTRIBUTES

Product Type: Fan Unit

Input Voltage AC: 230V

Package Quantity: 1

Finish: Aluminum-Zinc Plated

Material: Steel; Polypropylene

Net Weight: 4.09kg

ADDITIONAL PRODUCT DETAILS

Please order mains cable separately.

WARNING

nVent products shall be installed and used only as indicated in nVent's product instruction sheets and training materials. Instruction sheets are available at www.nvent.com and from your nVent customer service representative. Improper installation, misuse, misapplication or other failure to completely follow nVent's instructions and warnings may cause product malfunction, property damage, serious bodily injury and death and/or void your warranty.

North America

All locations
+1.763.422.2661
Chat with us:
nvent.com/schroff

Europe

Straubenhardt, Germany
+49.7082.794.0
Betschdorf, France
+33.3.88.90.64.90
Warsaw, Poland
+48.22.209.98.35
Assago, Italy
+39.02.932.7141
Chat with us:
nvent.com/schroff

Asia

Shanghai, China
+86.21.2412.6943
Qingdao, China
+86.532.8771.6101
Singapore
+65.6768.5800
Shin-Yokohama, Japan
+81.45.476.0271
Chat with us:
nvent.com/schroff

Middle East & India

Dubai, United Arab
Emirates
+971.4.378.1700
Bangalore, India
+91.80.6715.2001
Istanbul, Turkey
+90.216.250.7374
Chat with us:
nvent.com/schroff



Our powerful portfolio of brands:

CADDY ERICO HOFFMAN ILSCO SCHROFF TRACHTE