

Front Handle, Retrofitting for RatiopacPRO, RAL 7016, 6 U

CATALOG NUMBER

24571-303

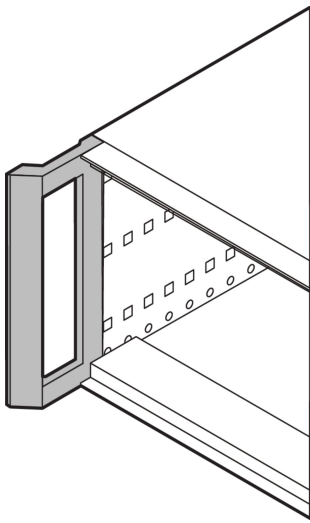

With this front handle the flexible and robust RatiopacPRO/-AIR case, is simple to convert for easier handling.

CERTIFICATIONS



FEATURES

For retrofitting of cases with cover strip and replace it by a front handle

PRODUCT ATTRIBUTES

Package Quantity: 2

Handle Type: Front Handle

Color: Grey

Finish: Powder Coated

Material: Aluminum

Product Family: RatiopacPRO

Product Type: Handle

Type: Static

Works With: Cases; RatiopacPRO

Gross Weight: 0.449kg

WARNING

nVent products shall be installed and used only as indicated in nVent's product instruction sheets and training materials. Instruction sheets are available at www.nvent.com and from your nVent customer service representative. Improper installation, misuse, misapplication or other failure to completely follow nVent's instructions and warnings may cause product malfunction, property damage, serious bodily injury and death and/or void your warranty.

North America

All locations
+1.763.422.2661
Chat with us:
nvent.com/schroff

Europe

Straubenhardt, Germany
+49.7082.794.0
Betschdorf, France
+33.3.88.90.64.90
Warsaw, Poland
+48.22.209.98.35
Assago, Italy
+39.02.932.7141
Chat with us:
nvent.com/schroff

Asia

Shanghai, China
+86.21.2412.6943
Qingdao, China
+86.532.8771.6101
Singapore
+65.6768.5800
Shin-Yokohama, Japan
+81.45.476.0271
Chat with us:
nvent.com/schroff

Middle East & India

Dubai, United Arab
Emirates
+971.4.378.1700
Bangalore, India
+91.80.6715.2001
Istanbul, Turkey
+90.216.250.7374
Chat with us:
nvent.com/schroff



Our powerful portfolio of brands:

CADDY ERICO HOFFMAN ILSCO SCHROFF TRACHTE