

# C-Rail Cable Shell, for Cable Bundle 18 ... 22 mm

## CATALOG NUMBER

**20118-775**

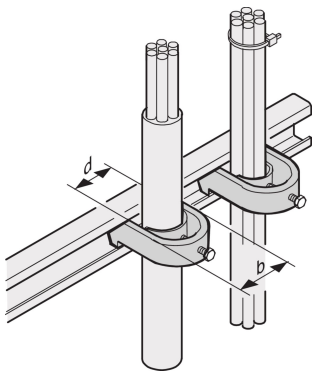

C-Rails are for better cable management. Installation generally behind the 19" uprights. They are compatible with standard cable clabs.

## CERTIFICATIONS



## FEATURES

For mounting of cables on C-profiles and cable support rails

## PRODUCT ATTRIBUTES

Finish: Tin Plated

Package Quantity: 10

Material: Steel

Product Family: Varistar CP

Product Type: Clamp

Type: Cable Clamp

Net Weight: 0.38kg

## WARNING

---

nVent products shall be installed and used only as indicated in nVent's product instruction sheets and training materials. Instruction sheets are available at [www.nvent.com](http://www.nvent.com) and from your nVent customer service representative. Improper installation, misuse, misapplication or other failure to completely follow nVent's instructions and warnings may cause product malfunction, property damage, serious bodily injury and death and/or void your warranty.

### North America

All locations  
+1.763.422.2661  
Chat with us:  
[nvent.com/schroff](http://nvent.com/schroff)

### Europe

Straubenhardt, Germany  
+49.7082.794.0  
Betschdorf, France  
+33.3.88.90.64.90  
Warsaw, Poland  
+48.22.209.98.35  
Assago, Italy  
+39.02.932.7141  
Chat with us:  
[nvent.com/schroff](http://nvent.com/schroff)

### Asia

Shanghai, China  
+86.21.2412.6943  
Qingdao, China  
+86.532.8771.6101  
Singapore  
+65.6768.5800  
Shin-Yokohama, Japan  
+81.45.476.0271  
Chat with us:  
[nvent.com/schroff](http://nvent.com/schroff)

### Middle East & India

Dubai, United Arab Emirates  
+971.4.378.1700  
Bangalore, India  
+91.80.6715.2001  
Istanbul, Turkey  
+90.216.250.7374  
Chat with us:  
[nvent.com/schroff](http://nvent.com/schroff)



Our powerful portfolio of brands:

**CADDY ERICO HOFFMAN ILSCO SCHROFF TRACHTE**