

# Varistar CP, Cable Support Rail for Cabinet Depth, 1000D, RAL 7021

## Data Solutions

### CATALOG NUMBER

23130-330

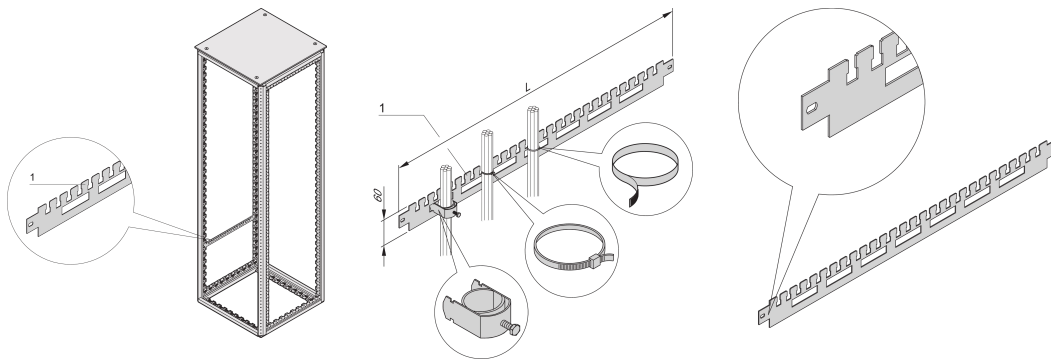

Varistar CP horizontal cable support rail in the cabinet depth. Mounted directly at the frame.

### CERTIFICATIONS



### FEATURES

For cable shells (bottom row) and for cable ties or Velcro (top row)

For cable ducting in side area of cabinet

### PRODUCT ATTRIBUTES

Package Quantity: 2

Color: Black Grey

Color Code: RAL 7021

Finish: Powder Coated

Material: Steel

Product Family: Varistar CP

Product Type: Support Rail

Type: Cable Support, Side Mount

Works With: Varistar CP

Net Weight: 1.3kg

## WARNING

---

nVent products shall be installed and used only as indicated in nVent's product instruction sheets and training materials. Instruction sheets are available at [www.nvent.com](http://www.nvent.com) and from your nVent customer service representative. Improper installation, misuse, misapplication or other failure to completely follow nVent's instructions and warnings may cause product malfunction, property damage, serious bodily injury and death and/or void your warranty.



Our powerful portfolio of brands:

**CADDY ERICO HOFFMAN ILSCO SCHROFF TRACHTE**