

Socket Strip, SCHUKO, 15 Sockets, With Switch

Data Solutions

CATALOG NUMBER

60110-208

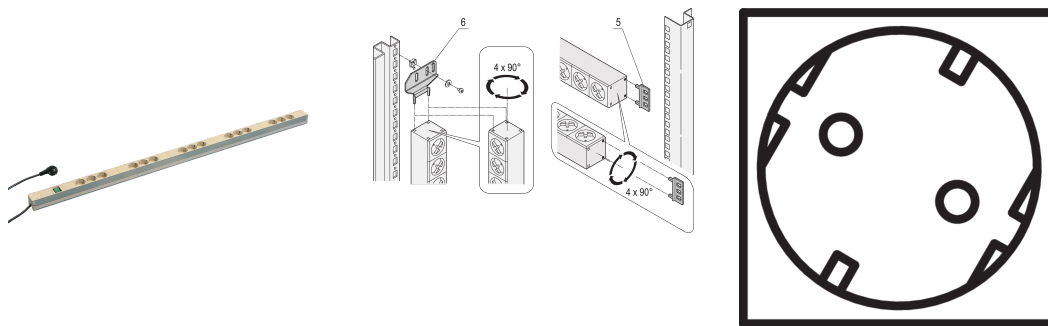

Modular, compact PDU with many function elements. Using a 1 U by 1 U aluminum chassis the PDU can easily be integrated in a rack with Schuko outlets.

CERTIFICATIONS



FEATURES

230 V, 16 A

Horizontal or vertical mounting

Connecting cable 2 m with SCHUKO/UTE plug

In accordance with DIN 57620, VDE 0620

Installation height 1 U

Socket strips with SCHUKO sockets

Socket strips can be rotated through all four directions (in 90° increments) during installation

PRODUCT ATTRIBUTES

Socket Type: SCHUKO

Socket Quantity: 15

Switched Outlets: Yes

Voltage AC: 230V

Package Quantity: 1

Color: Grey

Finish: Anodized

Material: Aluminum; Polyamide

Product Type: Socket Strip

Net Weight: 2.1kg

ADDITIONAL PRODUCT DETAILS

Please order mounting bracket for vertical mounting separately.

WARNING

nVent products shall be installed and used only as indicated in nVent's product instruction sheets and training materials. Instruction sheets are available at www.nvent.com and from your nVent customer service representative. Improper installation, misuse, misapplication or other failure to completely follow nVent's instructions and warnings may cause product malfunction, property damage, serious bodily injury and death and/or void your warranty.



Our powerful portfolio of brands:

CADDY ERICO HOFFMAN ILSCO SCHROFF TRACHTE