

Varistar CP | 19" Telescopic Shelf 70 kg, 600W 800D, RAL 7035

CATALOG NUMBER

22130-355

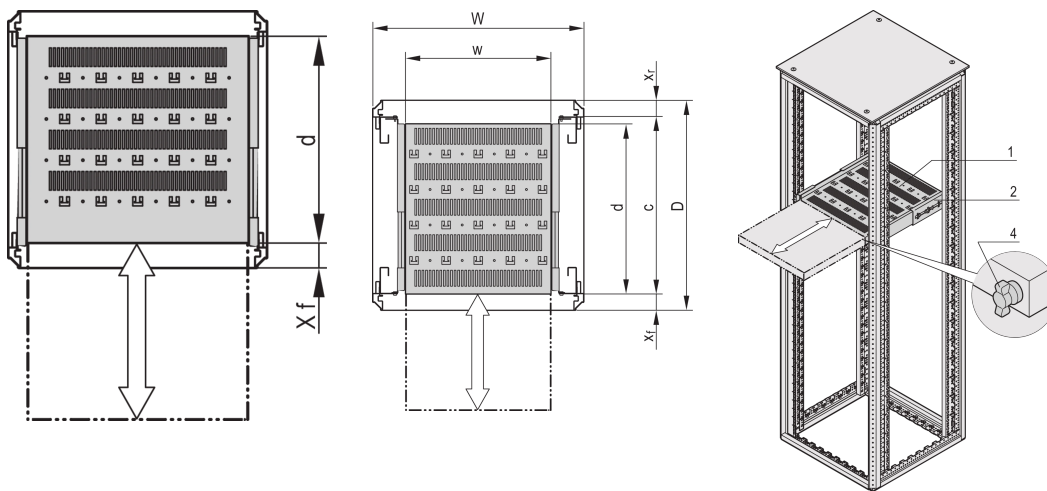

Varistar, Novastar and Eurorack 19" Shelf, Stationary with 70 kg load capacity, perforated for ease of assembly.

CERTIFICATIONS



FEATURES

Perforated cut-outs for assembling cable ties

Static load-carrying capacity 70 kg

Incl. telescopic slides

Locking with T-bar lock possible

St, 1.5 mm

Hammer head perforation for assembly with cable ties

PRODUCT ATTRIBUTES

Type: Telescopic Shelf

Package Quantity: 1

Color: Light Grey

Color Code: RAL 7035

Finish: Powder Coated

Material: Steel

Product Family: Varistar CP; Novastar

Product Type: Shelf

Gross Weight: 9.66kg

ADDITIONAL PRODUCT DETAILS

Mounting bracket for assembly of telescopic slide at frame please order separately.

Please order T-bar lock separately.

WARNING

nVent products shall be installed and used only as indicated in nVent's product instruction sheets and training materials. Instruction sheets are available at www.nvent.com and from your nVent customer service representative. Improper installation, misuse, misapplication or other failure to completely follow nVent's instructions and warnings may cause product malfunction, property damage, serious bodily injury and death and/or void your warranty.

North America

All locations
+1.763.422.2661
Chat with us:
nvent.com/schroff

Europe

Straubenhardt, Germany
+49.7082.794.0
Betschdorf, France
+33.3.88.90.64.90
Warsaw, Poland
+48.22.209.98.35
Assago, Italy
+39.02.932.7141
Chat with us:
nvent.com/schroff

Asia

Shanghai, China
+86.21.2412.6943
Qingdao, China
+86.532.8771.6101
Singapore
+65.6768.5800
Shin-Yokohama, Japan
+81.45.476.0271
Chat with us:
nvent.com/schroff

Middle East & India

Dubai, United Arab
Emirates
+971.4.378.1700
Bangalore, India
+91.80.6715.2001
Istanbul, Turkey
+90.216.250.7374
Chat with us:
nvent.com/schroff



Our powerful portfolio of brands:

CADDY ERICO HOFFMAN ILSCO SCHROFF TRACHTE