

Outdoor Unibody Cabinet With Single Door, 930H 16 U, 700W 500D

Data Solutions

CATALOG NUMBER

11249-003

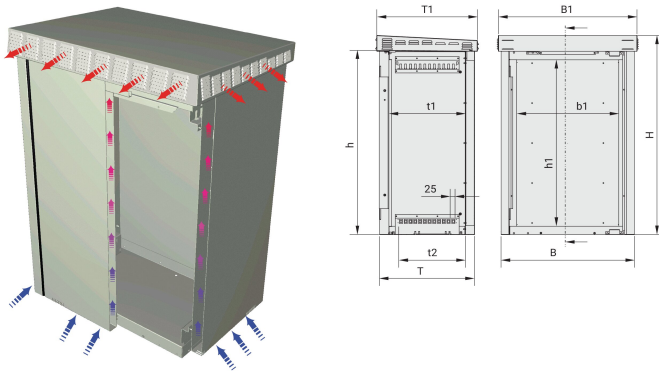

Telecom and Railway applications require sophisticated electronics in outdoor setups. nVent SCHROFF Outdoor cabinets shield such electronic components from extreme weather and vandalism, ensuring operational continuity.

CERTIFICATIONS



FEATURES

Double-walled, Al

IP 55

One-piece inner case with removable outer cladding

Heat dissipation through natural convection, max. 5 W/K (11249-003) / 6 W/K (11249-005)

PRODUCT ATTRIBUTES

Product Type: Outdoor Cabinet

Product Family: Unibody

Rack Height: 16U

Height: 930mm

Width: 700mm

Depth: 500mm

Wall Type: Double Walled

Door Type: Single Door

Access: Front

Cooling: Natural Convection

EMC Shielding: No

Complies With: IEC 61969-1; IEC 61969-2; IEC 60917-1; IEC 60917-2; ETS 300119; IEC 60529; DIN EN 50178; VDE 0160

Package Quantity: 1

Finish: Powder Coated

Material: Aluminum

Gross Weight: 44kg

ADDITIONAL PRODUCT DETAILS

Please order panel/slide mounts separately.

Further base/plinth heights on request.

Please order wall-mounting assembly kit separately.

WARNING

nVent products shall be installed and used only as indicated in nVent's product instruction sheets and training materials. Instruction sheets are available at www.nvent.com and from your nVent customer service representative. Improper installation, misuse, misapplication or other failure to completely follow nVent's instructions and warnings may cause product malfunction, property damage, serious bodily injury and death and/or void your warranty.



Our powerful portfolio of brands:

CADDY ERICO HOFFMAN ILSCO SCHROFF TRACHTE