

PCB Solder Side Cover, CPCI, 6 U, 233.35 mm x 80 mm,

CATALOG NUMBER

24579-039

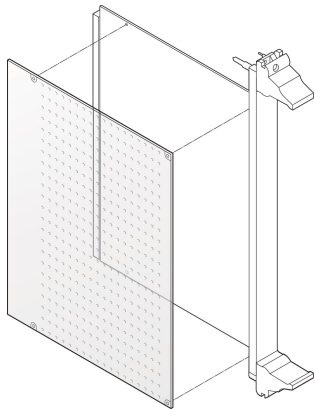

A solder side cover protects the solder side of a PCB mechanically.

CERTIFICATIONS



FEATURES

Cover is perforated for better cooling of components

Mechanical protection of solder side

PRODUCT ATTRIBUTES

Rack Height: 6U

Package Quantity: 1

Depth (D): 80mm

Material: Plastic

Product Type: Cover

Type: Solder Side Cover

Width (W): 233.35mm

Works With: Front Panels

Net Weight: 0.014kg

ADDITIONAL PRODUCT DETAILS

Fixing clips are required for mounting the perforated covers; please order separately.

DIAGRAMS

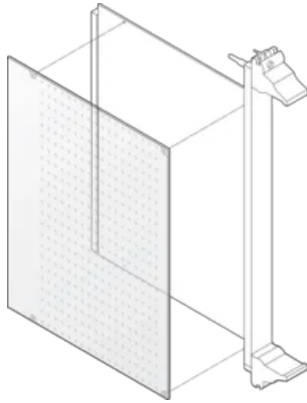

WARNING

nVent products shall be installed and used only as indicated in nVent's product instruction sheets and training materials. Instruction sheets are available at www.nvent.com and from your nVent customer service representative. Improper installation, misuse, misapplication or other failure to completely follow nVent's instructions and warnings may cause product malfunction, property damage, serious bodily injury and death and/or void your warranty.

North America

All locations
+1.763.422.2661
Chat with us:
nvent.com/schroff

Europe

Straubenhardt, Germany
+49.7082.794.0
Betschdorf, France
+33.3.88.90.64.90
Warsaw, Poland
+48.22.209.98.35
Assago, Italy
+39.02.932.7141
Chat with us:
nvent.com/schroff

Asia

Shanghai, China
+86.21.2412.6943
Qingdao, China
+86.532.8771.6101
Singapore
+65.6768.5800
Shin-Yokohama, Japan
+81.45.476.0271
Chat with us:
nvent.com/schroff

Middle East & India

Dubai, United Arab
Emirates
+971.4.378.1700
Bangalore, India
+91.80.6715.2001
Istanbul, Turkey
+90.216.250.7374
Chat with us:
nvent.com/schroff



Our powerful portfolio of brands:

CADDY ERICO HOFFMAN ILSCO SCHROFF TRACHTE