

19" Pusher Fan, 2 U, Axial, 230 VAC, Board Depth 160 mm, 445 - 530 m³h

NÚMERO DE CATÁLOGO

10713-534

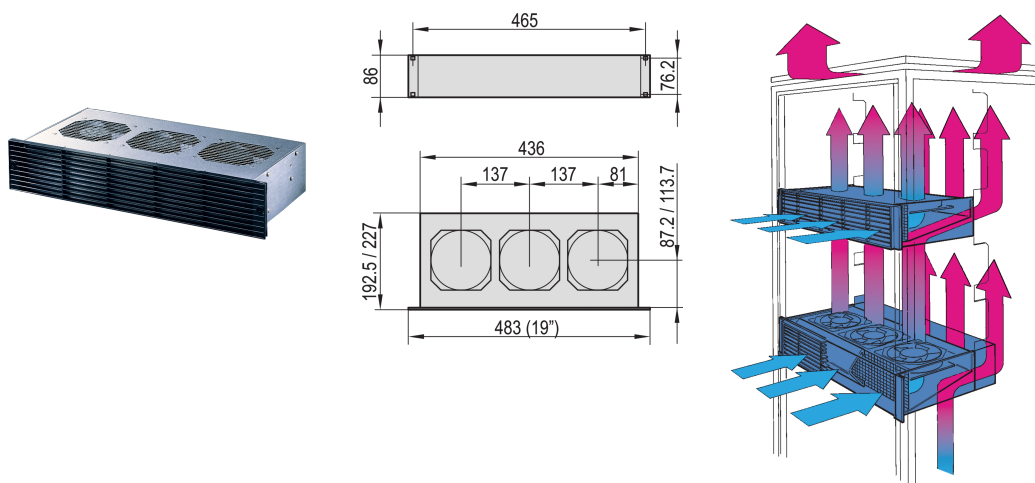

Fan tray with integrated pusher fan.

CERTIFICATIONS



CARACTERÍSTICAS

Contact protection in accordance with DIN EN ISO 13857

Integrated air deflector prevents heat buildup in the assemblies mounted below

Can be adapted to subracks

Optionally with additional rear fan, 2 U, for active cooling of assemblies beneath the pusher fan

CARATERÍSTICAS DO PRODUTO

Product Type: Fan Unit

Tensão de entrada AC: 230V

Quantidade por embalagem: 1

Acabamento: Aluminum-Zinc Plated

Material: Aço; Polypropylene

Net Weight: 4.09kg

DETALHES ADICIONAIS DO PRODUTO

Please order mains cable separately.

AVISO

Os produtos nVent devem ser instalados e utilizados apenas conforme indicado nas fichas de instrução do produto e materiais de treinamento da nVent. As fichas de instrução estão disponíveis em www.nVent.com e com nossos representantes de atendimento ao cliente nVent. A instalação inadequada, uso incorreto, aplicação incorreta ou outra falha qualquer em seguir completamente as instruções e avisos da nVent podem levar ao mau funcionamento do produto, danos à propriedade, lesões corporais graves e morte, e/ou anular sua garantia.

North America

All locations
+1.763.422.2661
Chat with us:
nvent.com/schroff

Europe

Straubenhardt, Germany
+49.7082.794.0
Betschdorf, France
+33.3.88.90.64.90
Warsaw, Poland
+48.22.209.98.35
Assago, Italy
+39.02.932.7141
Chat with us:
nvent.com/schroff

Asia

Shanghai, China
+86.21.2412.6943
Qingdao, China
+86.532.8771.6101
Singapore
+65.6768.5800
Shin-Yokohama, Japan
+81.45.476.0271
Chat with us:
nvent.com/schroff

Middle East & India

Dubai, United Arab
Emirates
+971.4.378.1700
Bangalore, India
+91.80.6715.2001
Istanbul, Turkey
+90.216.250.7374
Chat with us:
nvent.com/schroff



O nosso forte portfólio de marcas:

CADDY ERICO HOFFMAN ILSCO SCHROFF TRACHTE