

EMC Shielding Kit, Between Horizontal Rails, Stainless Steel, 84 HP

NÚMERO DE CATÁLOGO

24562-584

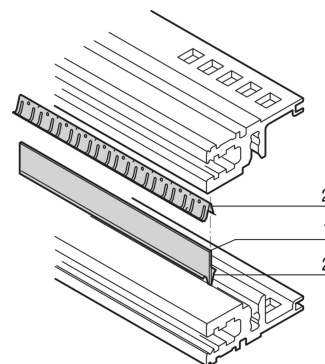

The contact strip makes contact between horizontal rails. If two horizontal rails are mounted one above the other, the seals plus a metal strip enable EMC shielding.

CERTIFICATIONS



CARACTERÍSTICAS

If two horizontal rails are mounted one above the other, the seals plus a metal strip enable EMC shielding

CARATERÍSTICAS DO PRODUTO

Rack Width: 84HP

Quantidade por embalagem: 1

Length: 431mm

Material: Aço inoxidável; Alumínio

Família de produtos: EuropacPRO

Product Type: Shielding Kit

Works With: Subracks

Net Weight: 0.05kg

AVISO

Os produtos nVent devem ser instalados e utilizados apenas conforme indicado nas fichas de instrução do produto e materiais de treinamento da nVent. As fichas de instrução estão disponíveis em www.nVent.com e com nossos representantes de atendimento ao cliente nVent. A instalação inadequada, uso incorreto, aplicação incorreta ou outra falha qualquer em seguir completamente as instruções e avisos da nVent podem levar ao mau funcionamento do produto, danos à propriedade, lesões corporais graves e morte, e/ou anular sua garantia.

North America

All locations
+1.763.422.2661
Chat with us:
nvent.com/schroff

Europe

Straubenhardt, Germany
+49.7082.794.0
Betschdorf, France
+33.3.88.90.64.90
Warsaw, Poland
+48.22.209.98.35
Assago, Italy
+39.02.932.7141
Chat with us:
nvent.com/schroff

Asia

Shanghai, China
+86.21.2412.6943
Qingdao, China
+86.532.8771.6101
Singapore
+65.6768.5800
Shin-Yokohama, Japan
+81.45.476.0271
Chat with us:
nvent.com/schroff

Middle East & India

Dubai, United Arab
Emirates
+971.4.378.1700
Bangalore, India
+91.80.6715.2001
Istanbul, Turkey
+90.216.250.7374
Chat with us:
nvent.com/schroff



O nosso forte portefólio de marcas:

CADDY ERICO HOFFMAN ILSCO SCHROFF TRACHTE