

EuropacPRO 19" Subrack Kit for Backplane, Heavy, Shielded, 3 U, 355 mm

NÚMERO DE CATÁLOGO

24563-174

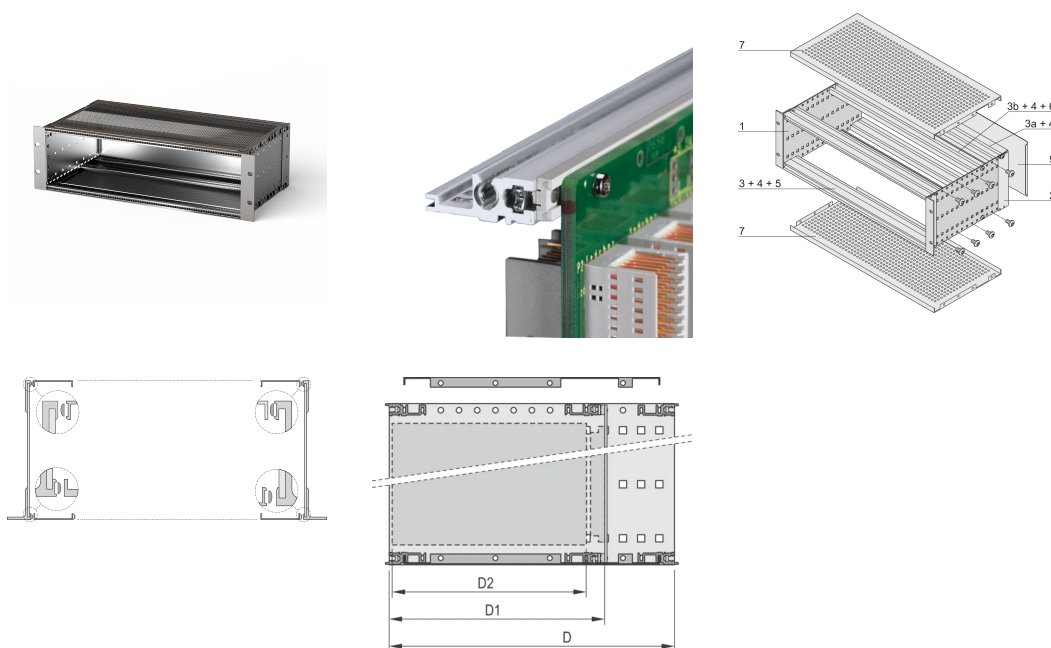

EMC Shielded subrack for backplane mounting, heavy version with tox welded side panels.

CERTIFICATIONS



CARACTERÍSTICAS

Subrack with side panel type H ("Heavy"), 19" bracket is firmly fixed to side panel (tox-cold welded)

Modifications such as cutouts, different finishes or dimensions available

Supplied as space-saving flat-pack

Aluminum construction

Horizontal rail type "Heavy"

Rear horizontal rail for backplane mounting with insulation strip

EMC of approximately 40 dB at 1 GHz, 30 dB at 2 GHz, assuming that the front is covered with shielded front panels, testing in accordance with VG 95373 part 15

Internal and external dimensions in accordance with: IEC 60297-3-100, -101, IEEE 1101.1

Shock and vibration tested to the German "Bahn" standards BN 411002, BN 411003

IP 20, in accordance with IEC 60529

CARATERÍSTICAS DO PRODUTO

Rack Height: 3U

Profundidade (D): 355mm

Quantidade por embalagem: 1

For Mounting: Backplane

Board Depth: 160mm; 220mm; 280mm

Gasket Type: Textile EMC

Shock and Vibration Tolerance: 5g (force)

Inclui alça: Não

Instalação: Rack

Em conformidade com: IEC 60297-3-103

EMC Shielding: Sim

Acabamento: Anodized; Passivated

Material: Alumínio

Product Type: Subrack/Chassis

Rack Width: 84HP

Static Load: 15kg

Net Weight: 3.3kg

DETALHES ADICIONAIS DO PRODUTO

Individual configuration: broad range of variants in height, width and depth; guide rails for a wide variety of applications; interior options; accessories and mounting material.



AVISO

Os produtos nVent devem ser instalados e utilizados apenas conforme indicado nas fichas de instrução do produto e materiais de treinamento da nVent. As fichas de instrução estão disponíveis em www.nVent.com e com nossos representantes de atendimento ao cliente nVent. A instalação inadequada, uso incorreto, aplicação incorreta ou outra falha qualquer em seguir completamente as instruções e avisos da nVent podem levar ao mau funcionamento do produto, danos à propriedade, lesões corporais graves e morte, e/ou anular sua garantia.

North America

All locations
+1.763.422.2661
Chat with us:
nvent.com/schroff

Europe

Straubenhardt, Germany
+49.7082.794.0
Betschdorf, France
+33.3.88.90.64.90
Warsaw, Poland
+48.22.209.98.35
Assago, Italy
+39.02.932.7141
Chat with us:
nvent.com/schroff

Asia

Shanghai, China
+86.21.2412.6943
Qingdao, China
+86.532.8771.6101
Singapore
+65.6768.5800
Shin-Yokohama, Japan
+81.45.476.0271
Chat with us:
nvent.com/schroff

Middle East & India

Dubai, United Arab
Emirates
+971.4.378.1700
Bangalore, India
+91.80.6715.2001
Istanbul, Turkey
+90.216.250.7374
Chat with us:
nvent.com/schroff



O nosso forte portefólio de marcas:

CADDY ERICO HOFFMAN ILSCO SCHROFF TRACHTE