

# EMC Shielding Kit, Between Horizontal Rails, Stainless Steel, 42 HP

NUMĂR DE CATALOG

24562-542

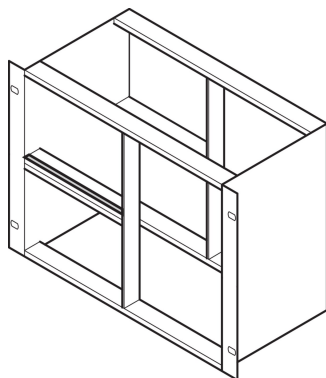

The contact strip makes contact between horizontal rails. If two horizontal rails are mounted one above the other, the seals plus a metal strip enable EMC shielding.

## CERTIFICATIONS



## CARACTERISTICI

If two horizontal rails are mounted one above the other, the seals plus a metal strip enable EMC shielding

## ATTRIBUTE PRODUS

Rack Width: 42HP

Package Quantity: 1

Length: 218mm

Material: Stainless Steel; Aluminiu

Product Family: EuropacPRO

Product Type: Shielding Kit

Works With: Subracks

Net Weight: 0.03kg

## AVERTIZARE

Produsele nVent trebuie instalate și utilizate numai așa cum este indicat în fișele de instrucțiuni și materialele de formare ale nVent. Fișele de instrucțiuni sunt disponibile pe [www.nvent.com](http://www.nvent.com) și de la reprezentantul dvs. de servicii clienți nVent. O instalare incorectă, o utilizare abuzivă, o aplicare greșită sau orice altă lipsă de respectare completă a instrucțiunilor și avertismentelor nVent poate duce la defectarea produsului, la deteriorarea proprietății, la răniri corporale grave și moarte și/sau poate anula garanția dvs.

### North America

All locations  
+1.763.422.2661  
Chat with us:  
[nvent.com/schroff](http://nvent.com/schroff)

### Europe

Straubenhardt, Germany  
+49.7082.794.0  
Betschdorf, France  
+33.3.88.90.64.90  
Warsaw, Poland  
+48.22.209.98.35  
Assago, Italy  
+39.02.932.7141  
Chat with us:  
[nvent.com/schroff](http://nvent.com/schroff)

### Asia

Shanghai, China  
+86.21.2412.6943  
Qingdao, China  
+86.532.8771.6101  
Singapore  
+65.6768.5800  
Shin-Yokohama, Japan  
+81.45.476.0271  
Chat with us:  
[nvent.com/schroff](http://nvent.com/schroff)

### Middle East & India

Dubai, United Arab Emirates  
+971.4.378.1700  
Bangalore, India  
+91.80.6715.2001  
Istanbul, Turkey  
+90.216.250.7374  
Chat with us:  
[nvent.com/schroff](http://nvent.com/schroff)



Portofoliul nostru puternic de mărci:

**CADDY ERICO HOFFMAN ILSCO SCHROFF TRACHTE**