

Guide Rail Standard Type, PC, 220 mm, 2 mm Groove Width, Red, 10 Pieces

NUMĂR DE CATALOG

24568-362

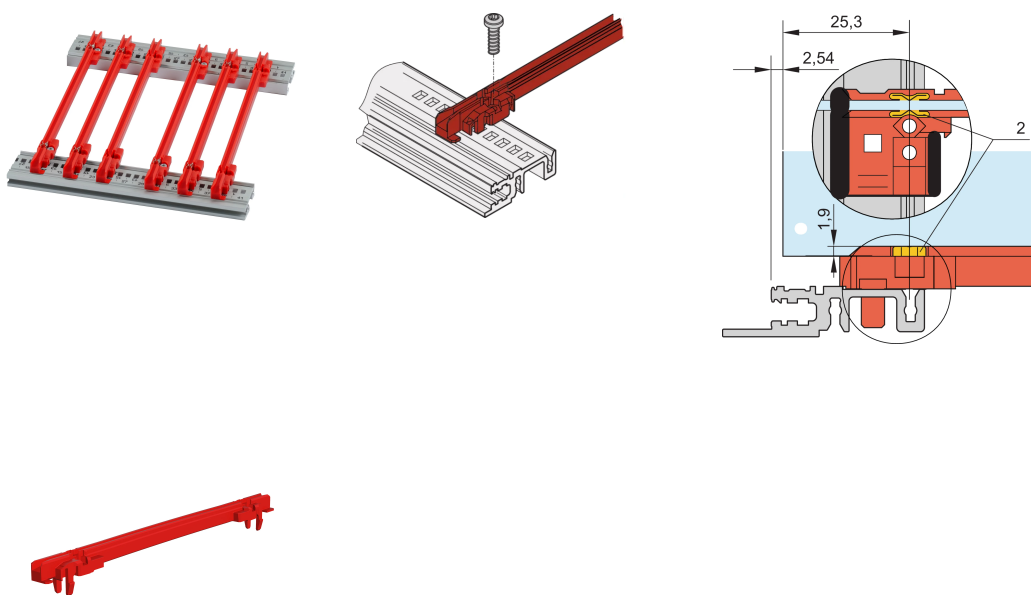

New generation of accessory type guide rails for PCBs or plug-in units. Forms a reliable interface between the subrack mechanics and the sub-assemblies.

CERTIFICATIONS



CARACTERISTICI

NEW generation Standard type plastic guide rails for reliable retention of PCBs or plug-in units

Significantly increased stability, due to a optimized design and high quality material (PC)

Improved fire safety properties, fulfills EN 45545-2 requirement sets R22, R23 and R24 with HL3

"Halogen-Free", according to IEC 61249-2-21

Can be clipped into horizontal rails (Al extrusion) or into 1.5 mm thick plates

Can be bolted to the horizontal rails Type H and R for higher shock and vibration requirements

Optional ESD clip for an conductive contact between PCB and horizontal rail available

Storage temperature: from -40 °C ... 130 °C

ATTRIBUTE PRODUS

Color: Red

Package Quantity: 10

Board Depth: 220mm

Groove Width: 2

Complies With: EN 45545-2

Material: Fiber-Reinforced Plastic

Product Family: EuropacPRO; RatiopacPRO; RatiopacPRO AIR; CompacPRO; PropacPRO; MultipacPRO; Inpac

Product Type: Guide Rail

Type: Standard

Works With: Subracks; Cases; 19" Chassis; Systems

Net Weight: 0.1kg

DETALII SUPLIMENTARE DESPRE PRODUS

Please take into consideration that deliveries may be carried out in the stated SPQs (SPQ, e.g. 5 pieces, 10 pieces, 50 pieces, etc.). Differing order quantities (e.g. 2 pieces) may be changed to the next possible delivery quantity = Standard Pack Quantity.

AVERTIZARE

Produsele nVent trebuie instalate și utilizate numai așa cum este indicat în fișele de instrucțiuni și materialele de formare ale nVent. Fișele de instrucțiuni sunt disponibile pe www.nvent.com și de la reprezentantul dvs. de servicii clienți nVent. O instalare incorectă, o utilizare abuzivă, o aplicare greșită sau orice altă lipsă de respectare completă a instrucțiunilor și avertismentelor nVent poate duce la defectarea produsului, la deteriorarea proprietății, la răniri corporale grave și moarte și/sau poate anula garanția dvs.

North America

All locations
+1.763.422.2661
Chat with us:
nvent.com/schroff

Europe

Straubenhardt, Germany
+49.7082.794.0
Betschdorf, France
+33.3.88.90.64.90
Warsaw, Poland
+48.22.209.98.35
Assago, Italy
+39.02.932.7141
Chat with us:
nvent.com/schroff

Asia

Shanghai, China
+86.21.2412.6943
Qingdao, China
+86.532.8771.6101
Singapore
+65.6768.5800
Shin-Yokohama, Japan
+81.45.476.0271
Chat with us:
nvent.com/schroff

Middle East & India

Dubai, United Arab
Emirates
+971.4.378.1700
Bangalore, India
+91.80.6715.2001
Istanbul, Turkey
+90.216.250.7374
Chat with us:
nvent.com/schroff



Portofoliul nostru puternic de mărci:

CADDY ERICO HOFFMAN ILSCO SCHROFF TRACHTE