

SGS Germany GmbH

Test Report No.: V0EE0007

Order No.: V0EE

Pages: 53

Client: Schroff GmbH

Equipment Under Test: EuropacPro Advanced EMC PLUS

Manufacturer: Schroff GmbH

Task: Evaluation of Shielding Effectiveness

Test Specification(s): acc. to IEC 61000-5-7
[covered by accreditation]

Result: see Summary

The results relate only to the items tested as described in this test report.

approved by:

Date

Signature

Bauer
Lab Manager EMC

May 29, 2024



More
Group Leader

May 29, 2024

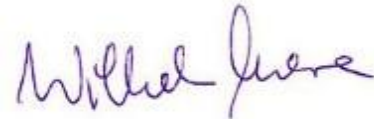

This document was signed electronically.

SGS Germany GmbH, Benzstr. 26/28, D-82178 Puchheim, and Traunreuter Str. 3, D-82538 Geretsried-Gelting are testing facilities
for

ELECTRO-MECH. COMPONENTS TESTING ENVIRONMENTAL SIMULATION ELECTROMAGNETIC COMPATIBILITY
MEDICAL DEVICE TESTING BATTERY TESTING PRODUCT SAFETY TELECOM CONFORMANCE TESTS

Phone +49 89-787475-100, Internet www.sgs-cqe.de

CONTENTS

1 Summary	4
1.1 Common	4
1.2 Execution of the measurements	4
1.3 EM shielding code designators of IEC 61000-5-7	4
1.4 Summary of Results	5
2 References	5
2.1 Specifications	5
2.2 Glossary of Terms	5
3 General Information.....	6
3.1 Identification of Client	6
3.2 Test Laboratory	6
3.3 Time Schedule	6
3.4 Participants	6
4 Equipment Under Test.....	7
4.1 Photographs of EUT	8
5 Test Equipment.....	9
5.1 Test Facility	9
5.2 Measuring Equipment	9
5.3 Test Setup.....	9
5.3.1 Testing above 20 GHz	10
5.4 Measurement Uncertainty	10
5.5 Statement of Conformity & Decision Rule.....	10
6 Results	12
6.1 Summary of Results	12
6.2 0.01 – 30 MHz.....	13
6.2.1 Test Setup	13
6.2.2 Measuring Equipment	13
6.2.3 Photographs of test setup for reference measurements	14
6.2.4 Dynamic range (with Sonoma, BW = 10 Hz) (eut_0)	16
6.2.5 Test Results	17
6.2.5.1 Front	17
6.2.5.2 Side.....	19
6.2.5.3 Top.....	21
6.2.5.4 Worst case	23
6.3 30 – 1000 MHz.....	24

The test report shall not be reproduced except in full without the written approval of the testing laboratory

6.3.1 Test Setup	24
6.3.2 Measuring Equipment	24
6.3.3 Photographs of test setup for reference measurements	25
6.3.4 Dynamic range with Sonoma, BW = 10 Hz) (eut_0)	27
6.3.5 Test Results	28
6.3.5.1 Front	28
6.3.5.2 Side.....	30
6.3.5.3 Top.....	32
6.3.5.4 Worst case	34
6.4 1 – 18 GHz	35
6.4.1 Test Setup	35
6.4.2 Measuring Equipment	35
6.4.3 Photographs of test setup for reference measurements	36
6.4.4 Dynamic range.....	37
6.4.5 Test Results	38
6.4.5.1 Front	38
6.4.5.2 Side.....	39
6.4.5.3 Top.....	41
6.4.5.4 Worst case	43
6.5 18 – 40 GHz (single frequencies only).....	44
6.5.1 Setup	44
6.5.2 Test Setup	44
6.5.3 Measuring Equipment	44
6.5.4 Photographs of test setup	45
6.5.5 Test Results	46
6.5.5.1 Front	46
6.5.5.2 Side.....	48
6.5.5.3 Top.....	50
6.5.5.4 Worst case	52
7 Disclaimer	53

The test report shall not be reproduced except in full without the written approval of the testing laboratory

1 Summary

1.1 Common

The shielding effectiveness of the EuropacPro Advanced EMC PLUS should be measured acc. to IEC 61000-5-7 in the frequency range 10 kHz to 40 GHz.

1.2 Execution of the measurements

The measurements of the shielding effectiveness of the EUT were performed with three sides of EUT facing the antenna:

1. Front
2. Right side
3. Top

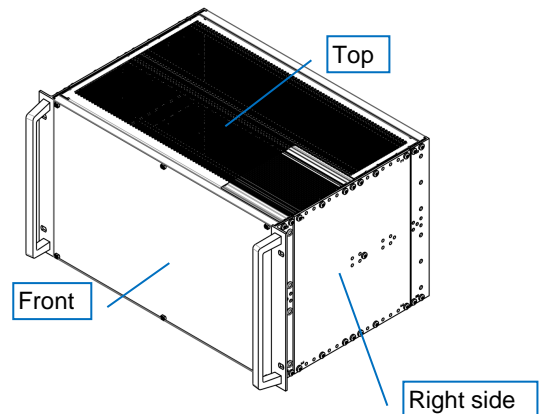

The measurements were performed in the following frequency ranges:

- 0.01 – 30 MHz
- 30 – 1000 MHz
- 1 – 18 GHz
- 18 – 40 GHz ¹

1.3 EM shielding code designators of IEC 61000-5-7

In Table 1 of IEC 61000-5-7, the following EM shielding code designators are defined:

Table 1 – EM shielding code designators

Frequency band	Shielding designator	Shielding performance dB	Shielding designator value
10 kHz – 100 kHz	A	Untested	x
100 kHz – 1 MHz	B	<10	0
1 MHz – 30 MHz	C	≥10	1
30 MHz – 1 GHz	D	≥20	2
1 GHz – 10 GHz	E	≥30	3
10 GHz – 40 GHz	F	≥40	4
		≥50	5
		≥60	6
		≥70	7
		≥80	8
		≥100	9

¹ In this frequency range the shielding effectiveness was evaluated at the following spot frequencies: 20, 24, 28, 32, 36 and 40 GHz.

1.4 Summary of Results

The EM code acc. to IEC 61000-5-7 derived from the results of shielding effectiveness measurements is

EM123211

Table 1-1 shows the minimum shielding effectiveness in the Frequency Bands acc. to IEC 61000-5-7 and the correlated performance levels.

Frequency Band (MHz)	Shielding designator	Minimum shielding effectiveness (dB) ²	Performance level
0.01 – 0.1	A	17.4	1
0.1 – 1	B	25.2	2
1 – 30	C	39.0	3
30 – 1,000	D	26.2	2
1,000 – 10,000	E	13.4	1
10,000 – 40,000	F	15.9	1

Table 1-1

2 References

2.1 Specifications

- IEC 61000-5-7: 2001-01
Electromagnetic compatibility (EMC) –
Part 5-7:
Installation and mitigation guidelines –
Degrees of protection provided by enclosures against electromagnetic disturbances (EM code)

2.2 Glossary of Terms

EMC specific Abbreviations

BW	Bandwidth
EMC	Electromagnetic Compatibility
EMI	Electromagnetic Interference
EN	European Standard
EUT	Equipment Under Test
IEC	International Electrotechnical Commission
IEEE	Institute of Electrical and Electronics Engineers
SE	Shielding Effectiveness
SW	Software
RX	receive
TX	transmit
VNA	Vectorial Network Analyzer
VSWR	Voltage Standing Wave Ratio

² Read from smoothed results.

3 General Information

3.1 Identification of Client

Schroff GmbH
Langenalber Str. 96-100
75334 Straubenhardt

3.2 Test Laboratory

SGS Germany GmbH
Hofmannstraße 50
81379 München

Business Address: SGS Germany GmbH, Heidenkampsweg 99, D-20097 Hamburg, Member of the SGS Group
General Manager: Dr Tomasz P Bednarczyk, Chairman of the Supervisory Board: Malcolm Reid
Registered Office: Hamburg, HRB 4951 Amtsgericht Hamburg

3.3 Time Schedule

Delivery of EUT: Apr 09, 2024
Start of test: Apr 16, 2024
End of test: Apr 19, 2024

3.4 Participants

Name	Function
Andreas Pauli	Accredited testing, Editor
Cedric Njoteng Ngankam	Accredited testing

3.5 Environmental conditions

During the measurement the environmental conditions were within the listed ranges:

Temperature: 20 - 26 °C
Humidity: 30 - 60 %

The test report shall not be reproduced except in full without the written approval of the testing laboratory

4 Equipment Under Test

All information regarding the EUT(s) was provided by the customer and has been approved by customer during report-review-process.

Test item description 19-inch Subrack EuropacPro, Advanced EMC PLUS Version, front panels with textile gasket (60100-560)

Trade Mark: nVent

Manufacturer / Importer: Schroff GmbH

Model/Type: EuropacPro

Dimensions: Rack Height: 6 U
Rack Width: 84 HP
Depth: 295 mm

Serial No.: 24563-931
2x 84HP front panel (20848-189; front and back)
42x guide rails (64560-001; 21 slots)

Number of tested samples.: 1

The test report shall not be reproduced except in full without the written approval of the testing laboratory

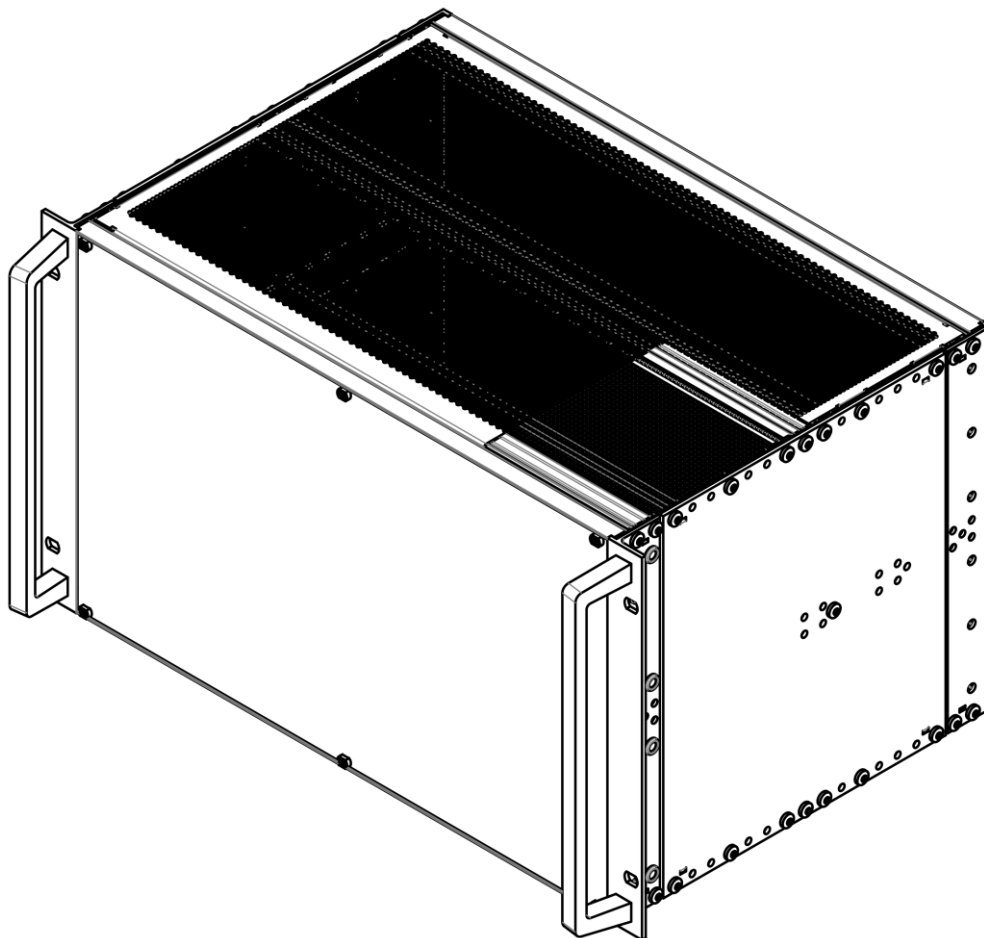

Figure 4-1: EUT

4.1 Photographs of EUT



Figure 4-2: EuropacPro Advanced EMC PLUS

The test report shall not be reproduced except in full without the written approval of the testing laboratory

Prior to the measurement of a shielding effectiveness a reference measurement is done. For that the TX and RX antennas are positioned in the predefined distance to each other, connected to the VNA with the same cabling and preamplifiers (optional) as used during the subsequent measurements.

At each antenna, an attenuator pad is applied to improve the VSWR.

For measurement of the shielding effectiveness, the RX antenna is located inside the EUT in front of the selected measuring point with distances to metallic surfaces as large as possible. The TX antenna is positioned outside the EUT directly opposite so that the overall distance between the antennas is the same as during the reference measurement.

Now the measurement is started again, and the shielding effectiveness is calculated automatically by the software.

5.3.1 Testing above 20 GHz

In the frequency range above 20 GHz, instead of the VNA a signal generator together with a frequency doubler was used as sender. The receiving antenna was connected to an EMI receiver.

In this frequency range, no automatic measurement is possible. Therefore, the shielding effectiveness in this frequency range is performed manually at selected frequencies.

5.4 Measurement Uncertainty

As far as the underlying standards include requirements concerning the uncertainty of measuring instruments or measuring methods, they are met.

The expanded measurement uncertainty of the measuring chain was calculated for all tests according to the "ISO Guide to the expression of uncertainty in measurement (GUM)". The results are documented in an "internal controlled document".

The measuring accuracy for all measuring devices is given in their technical description. The measuring instruments, including any accessories, are calibrated respectively verified to ensure the necessary accuracy. Depending on the kind of measuring equipment it is checked within regular intervals or directly before the measurement is performed. Adjustments are made and correction factors applied to measured data in accordance with the specifications of the specific instrument.

The expanded measurement instrumentation uncertainty of our Test Laboratory meets the requirements of IEC CISPR 16-4-2 "Specification for radio disturbance and immunity measuring apparatus and methods – Part 4-2: Uncertainties, statistics and limit modeling – Uncertainty in EMC measurements" for all listed tests.

5.5 Statement of Conformity & Decision Rule

If not otherwise stated, the Decision Rule is considered in different ways.

Emission based on CISPR 11, CISPR 14-1, CISPR 15, CISPR 32, CISPR 36, IEC 61000-6-3, IEC 61000-6-4:

The decision rule for statement of conformity is based on U_{CISPR} given in CISPR 16-4-2. The

relevant MIU (Measurement Instrumentation Uncertainty) calculations U_{LAB} of the EMC-lab for the single emission tests is below U_{CISPR} . Therefore, it can be considered that the measurement result is valid without any need of adaption and e.g., a result of 0 dB to the limit can be stated as pass.

All other emission tests:

For all other emission tests, the relevant MIU have been calculated by the EMC-lab and U_{LAB} keep typical levels. In this case, the “Binary Statement for Simple Acceptance Rule” acc. 4.2.1 of ILAC G8:2019 is applied. The result can be considered to be passed if the measurement value is at least equal to the limit. Probability is only 50% in this case. If the measured value is below the limit by the amount of the measurement uncertainty, the risk of an incorrect assumption is already reduced to 2.5%.

Immunity

The calculated MIU U_{LAB} of the test levels are according to the requirements of the corresponding test standards. As the influence of the characteristics of the test disturbance is not known and the DUT shows non-linear system behaviour in most cases, no decision rule can be stated for immunity tests.

6 Results

The test results in the report refer exclusively to the test object described in section 4 and the test period in section 3.3. The results apply to the sample(s) as received.

6.1 Summary of Results

The EM code acc. to IEC 61000-5-7 derived from the results of shielding effectiveness measurements is

EM123211

Table 6-1 shows the minimum shielding effectiveness in the Frequency Bands acc. to IEC 61000-5-7 and the correlated performance levels.

Frequency Band (MHz)	Shielding designator	Minimum shielding effectiveness (dB) ³	Performance level
0.01 – 0.1	A	17.4	1
0.1 – 1	B	25.2	2
1 – 30	C	39.0	3
30 – 1,000	D	26.2	2
1,000 – 10,000	E	13.4	1
10,000 – 40,000	F	15.9	1

Table 6-1

The test report shall not be reproduced except in full without the written approval of the testing laboratory

³ Read from smoothed results.

6.2 0.01 – 30 MHz

Tested by : Pauli

Test date : 2024-04-16

Test location : EMC chamber No. 2

6.2.1 Test Setup

- Antenna distance = 0.40 m (between outer diameter of TX loop and center of RX loop)
- TX Antenna height = 1.00 m (center)
- RX Antenna height = 0.94 m (center)
- no preamp in RX path for Reference measurements
- preamp P1182 in RX path for EUT measurements
- amplifier P1087 (25W) @ TX antenna
- no attenuator at TX antenna
- no attenuator at RX antenna
- measuring bandwidth = 10Hz
- Number of points = 401

6.2.2 Measuring Equipment

ID	Measuring Instrument	Specification	Status	Due date
P1728	antenna	9 kHz - 30 MHz	cnn	
P2361	Passive RX-Loop Antenna	9 kHz - 400 MHz, 1 turn, loop diameter 50 mm	cal	Jun 30, 2024
P1944	Point2Point - AC Coupled Fibre Optic Link	2 kHz to 1.35 GHz, 0 dBm Input/Output	chk	Jan 31, 2025
P1547	Network Analyzer	9 kHz - 4 GHz	cal	Mar 31, 2025
P1182	preamplifier	9 kHz - 1000 MHz, 32dB gain, +10dBm	cal	Mar 31, 2026
P1087	amplifier	0.01 - 100 MHz, 25 W	cnn	
P2541	Coax cable 4m (with ferrites)	50 Ohm, 3GHz	cnn	
P2578	coax cable 0.45 m, N - SMA	DC - 18 GHz, 0.8 dB @ 18 GHz	cnn	
P2813	EMC chamber 2 (SAC5 light)	12.4 m x 7.3 m x 6.3 m (l x w x h) (net), 1 m hybrid absorbers; Walls: Pyramidal hybrid absorber 12, 18 and 30 inch; Ceiling: Pyramidal hybrid absor	chk	
	coax cable, L = 1,5m, N	Innen, von CP2 zu Amplifier	cnn	
	coax cable, L = 4m	Außen, von ZVLR zu Access panel	cnn	

cal = Calibration, car = Calibration restricted use, chk = Check, chr = Check restricted use, cpu = Check prior to use, calchk = Calibration and check, ind = for indication only, cnn = Calibration not necessary, service = Wartung (Service), man = Maintenance, calservice = Calibration & Service, chkservice = Check & Service, calchkservice = Calibration & Check & Service, calinit = Initial Calibration only

6.2.3 Photographs of test setup for reference measurements

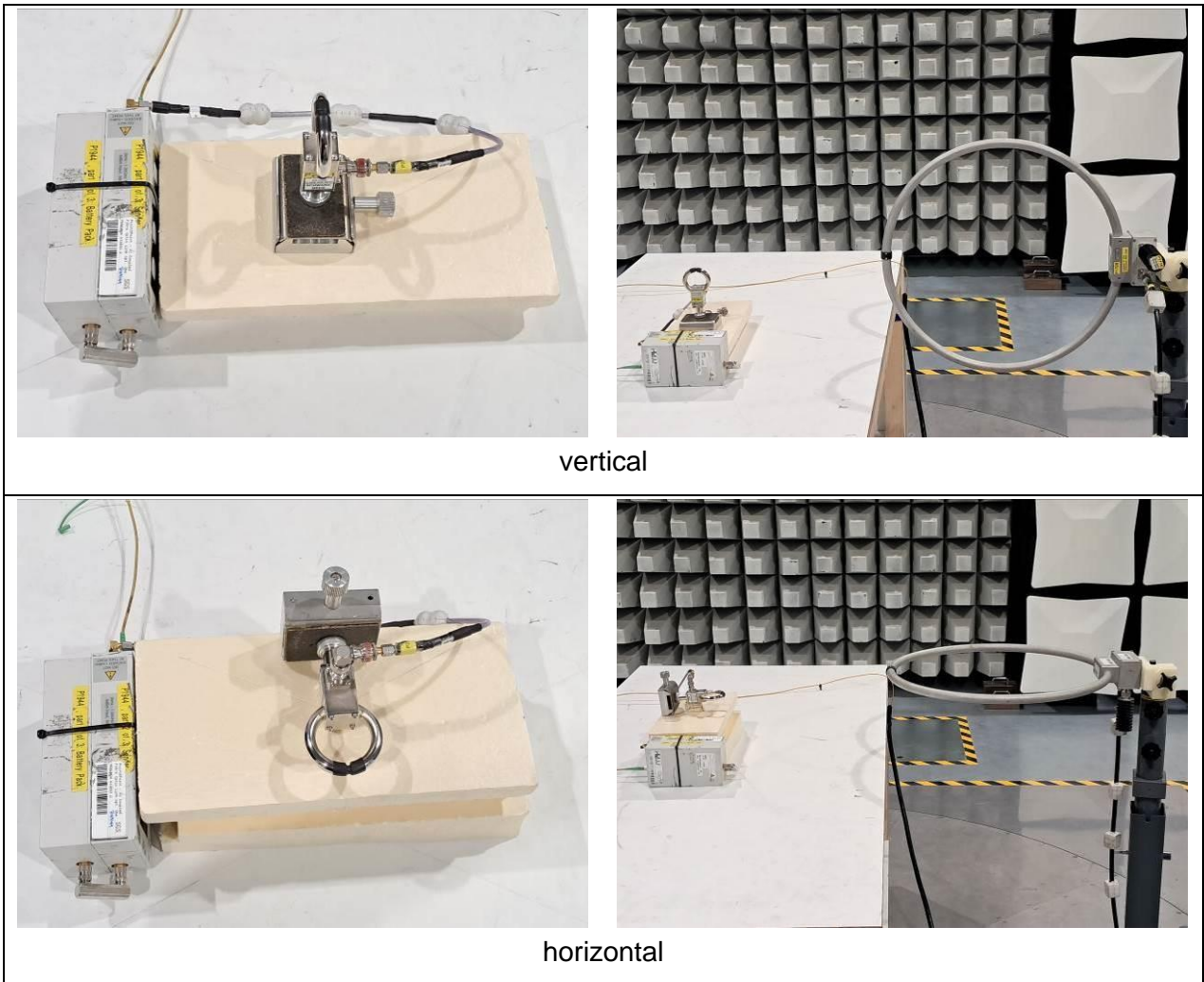
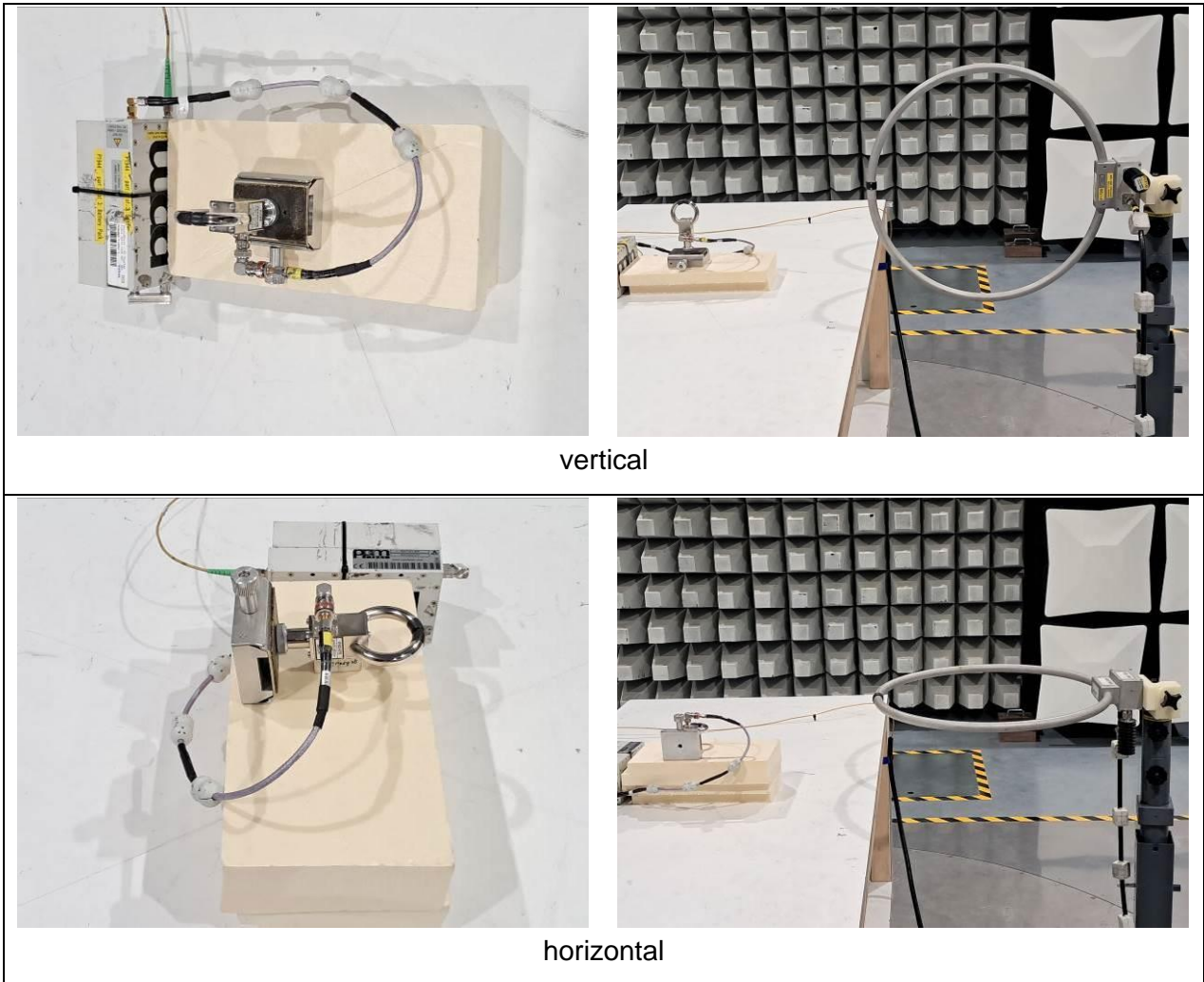

Figure 6-1: test setup reference measurements for position front/top

The test report shall not be reproduced except in full without the written approval of the testing laboratory



vertical

horizontal

Figure 6-2: test setup reference measurements for position side

The test report shall not be reproduced except in full without the written approval of the testing laboratory

6.2.4 Dynamic range (with Sonoma, BW = 10 Hz) (eut_0)

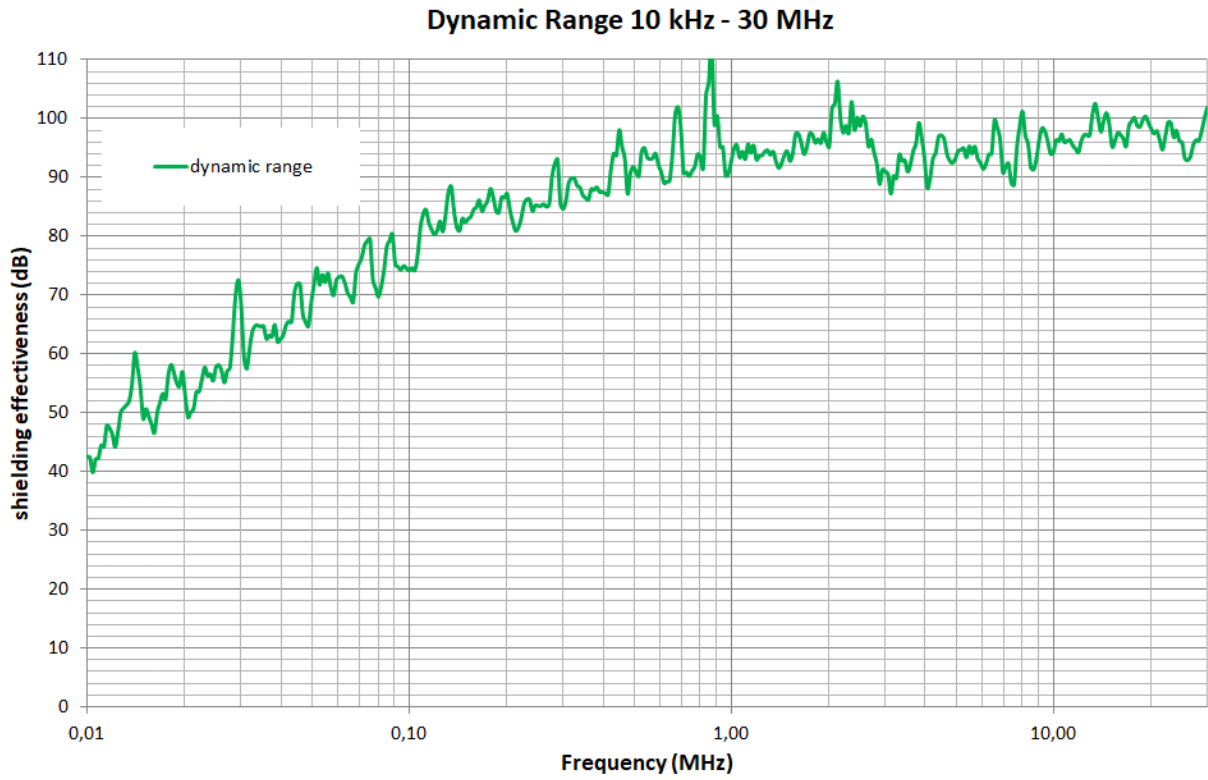

The test report shall not be reproduced except in full without the written approval of the testing laboratory

6.2.5 Test Results

6.2.5.1 Front

Shielding effectiveness 10 kHz - 30 MHz, Front

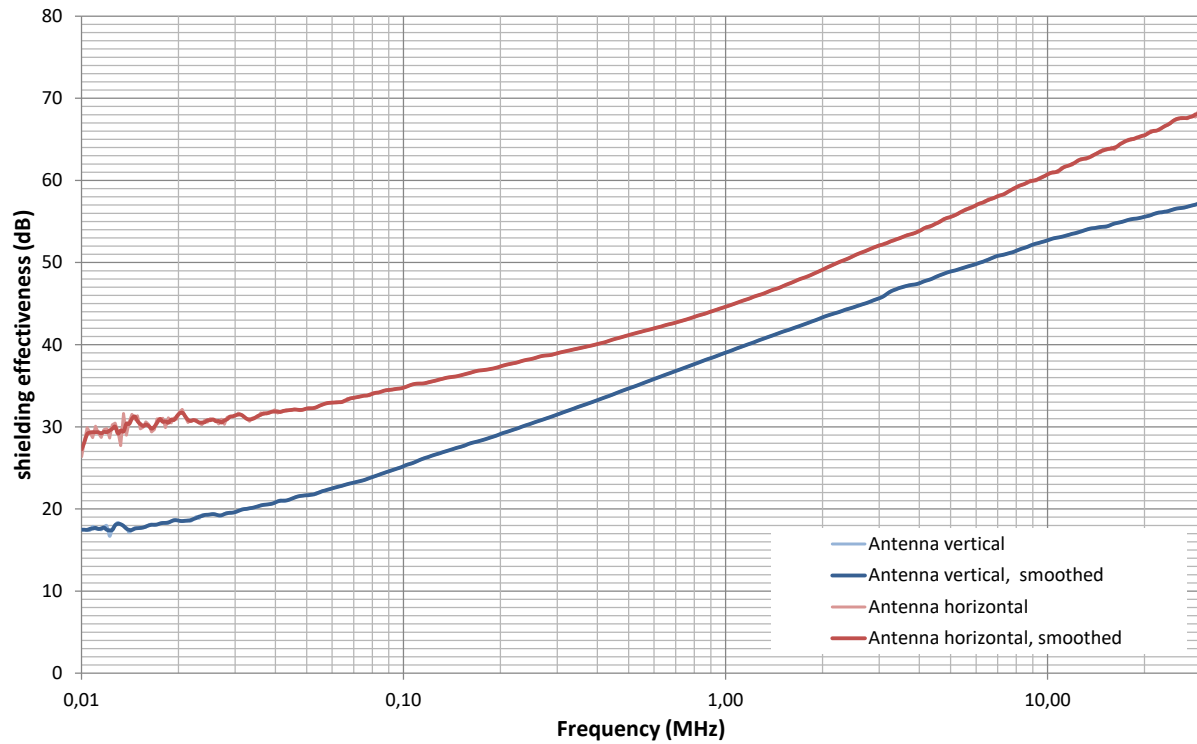

The test report shall not be reproduced except in full without the written approval of the testing laboratory

Photo documentation of the test set-up:

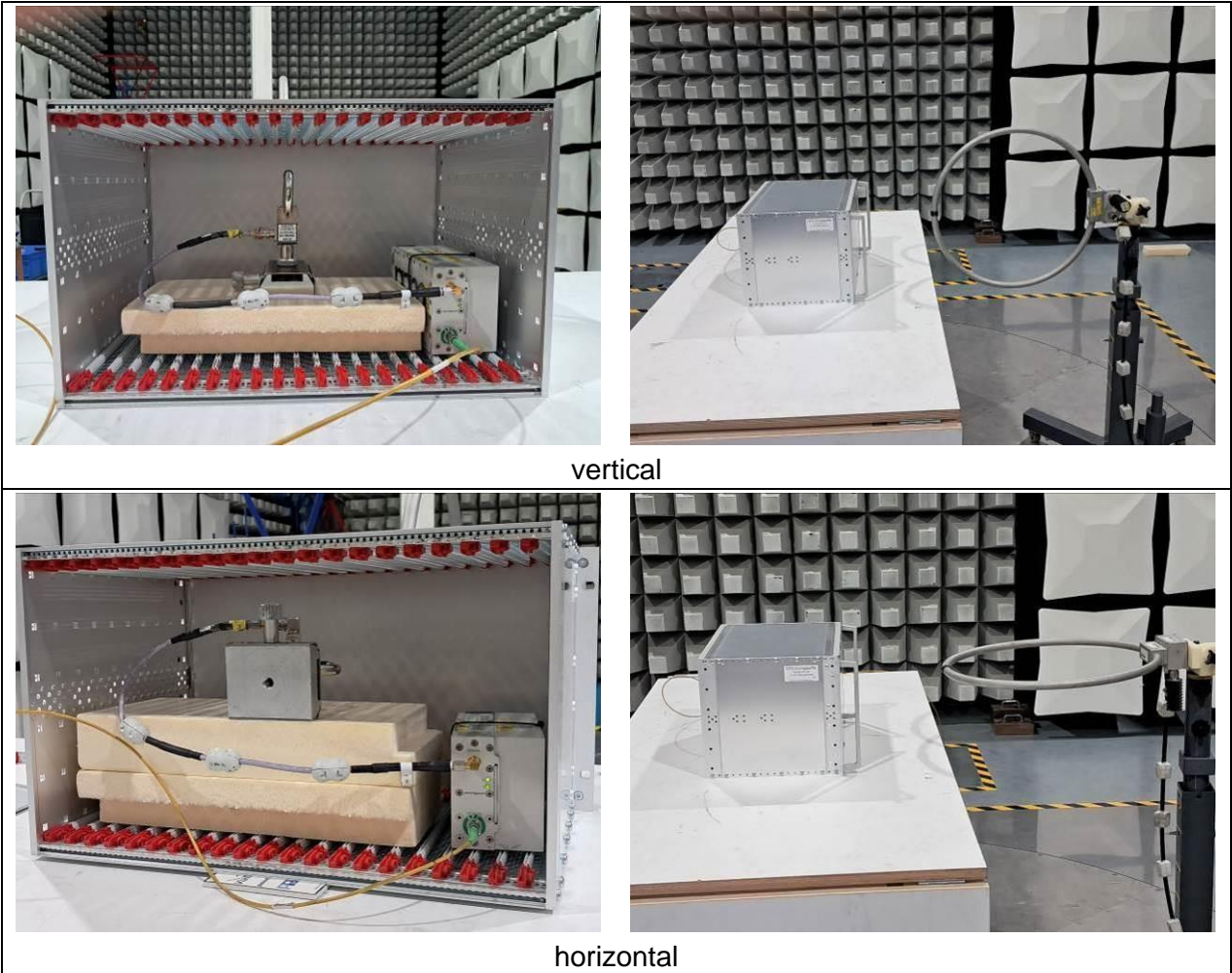
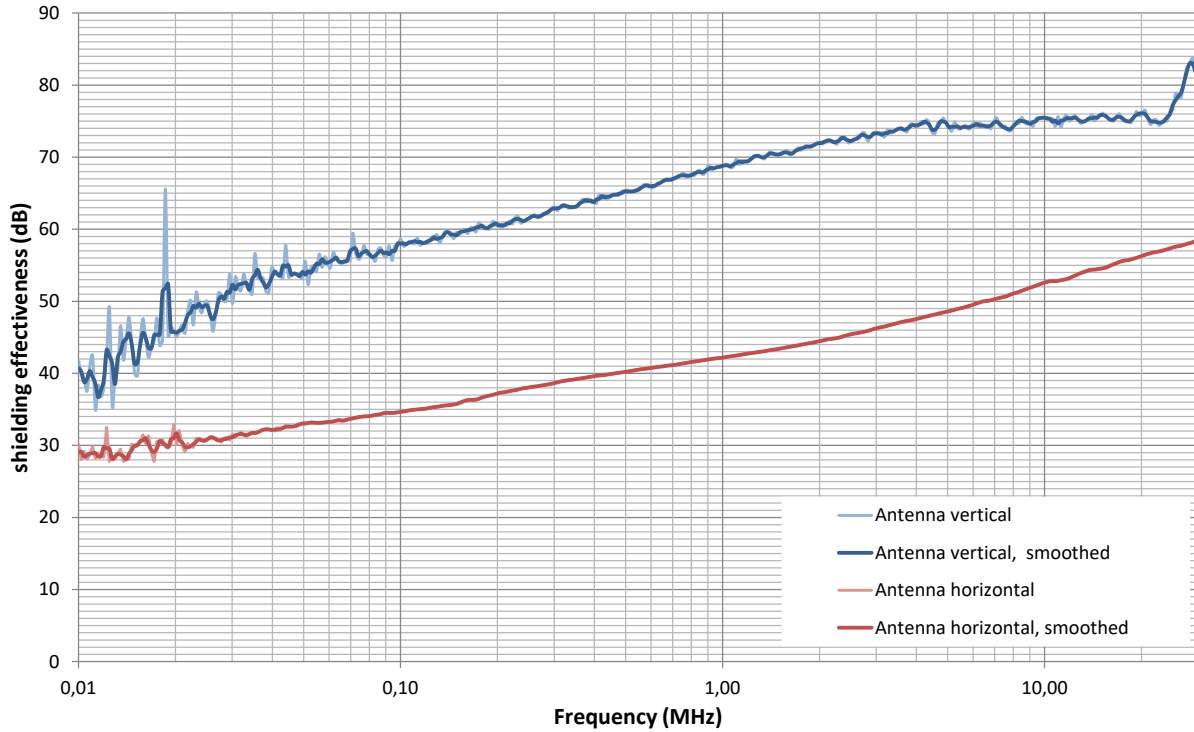

Figure 6-3: test setup 0.01 – 30 MHz

The test report shall not be reproduced except in full without the written approval of the testing laboratory

6.2.5.2 Side

Shielding effectiveness 10 kHz - 30 MHz, Side



The test report shall not be reproduced except in full without the written approval of the testing laboratory

Photo documentation of the test set-up:

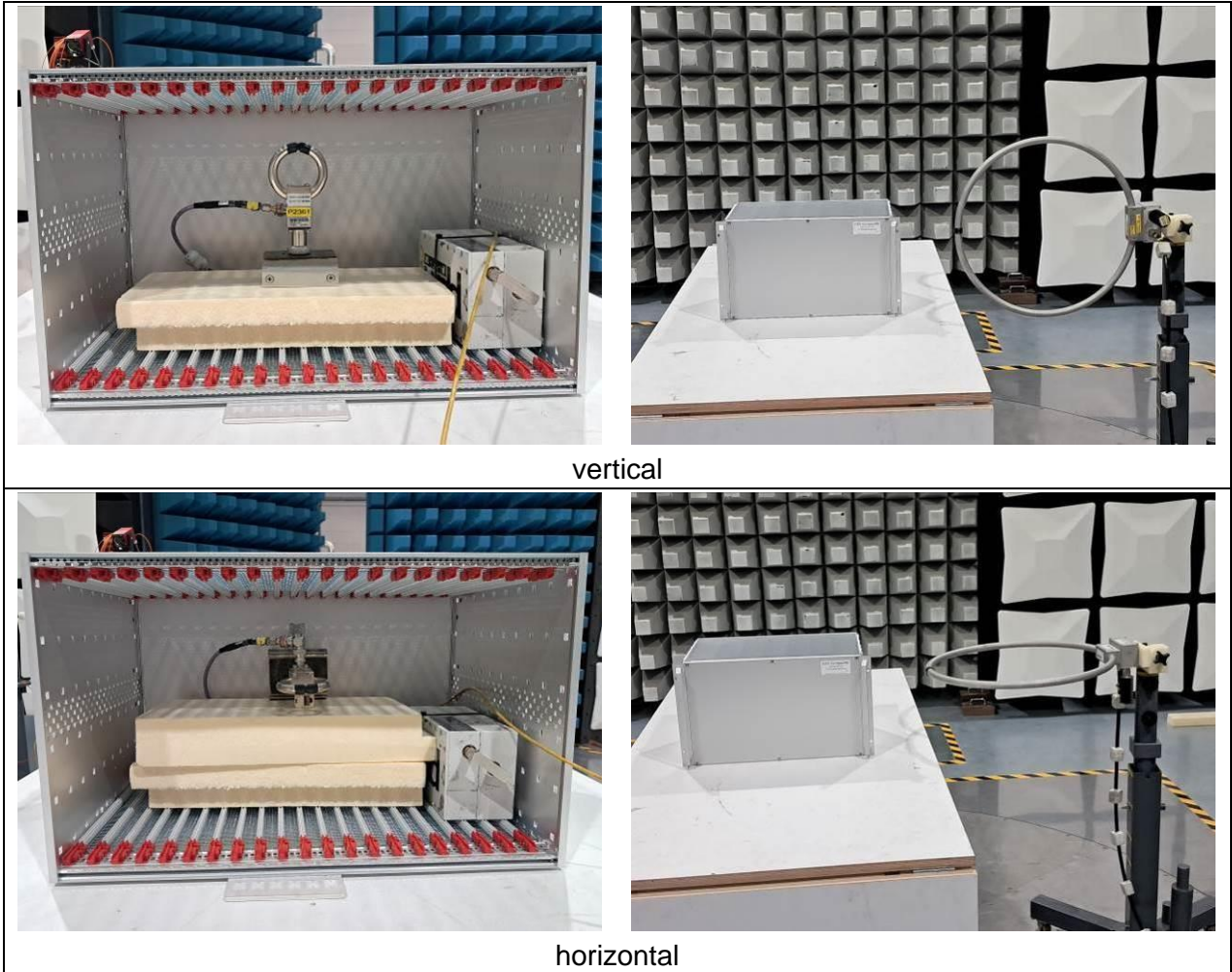

vertical

horizontal

Figure 6-4: test setup 0.01 – 30 MHz

The test report shall not be reproduced except in full without the written approval of the testing laboratory

6.2.5.3 Top

Shielding effectiveness 10 kHz - 30 MHz, Top

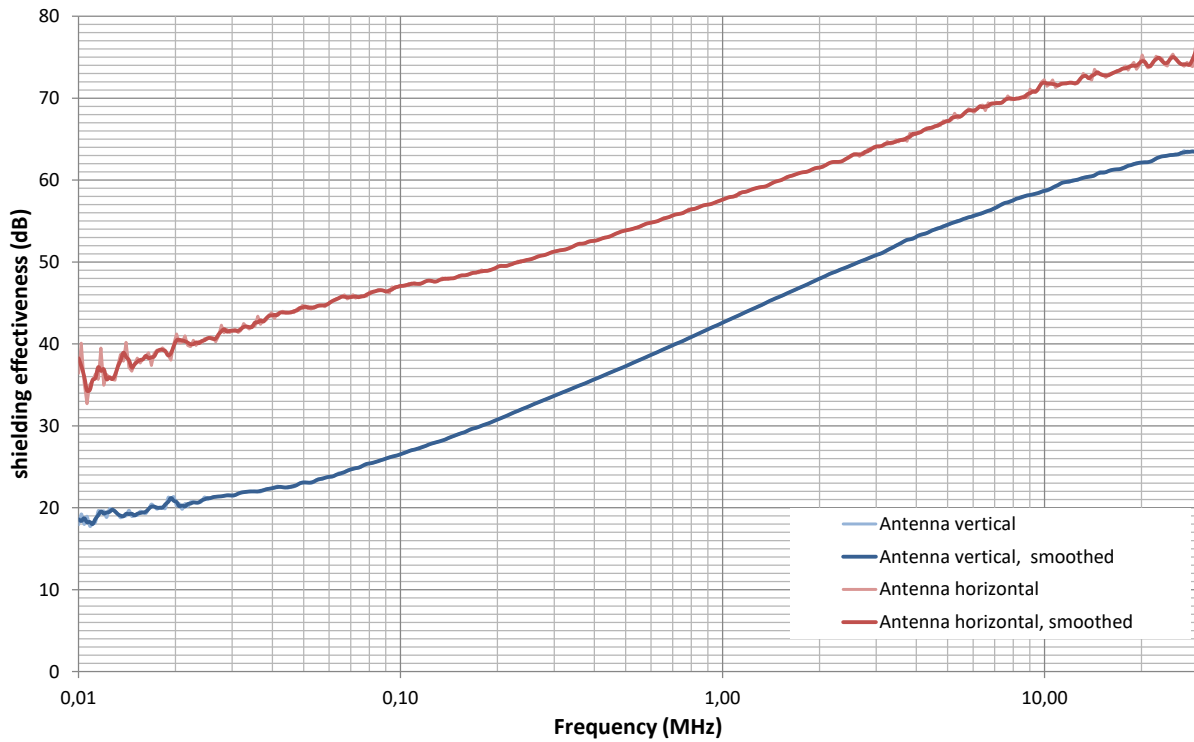

The test report shall not be reproduced except in full without the written approval of the testing laboratory

Photo documentation of the test set-up:

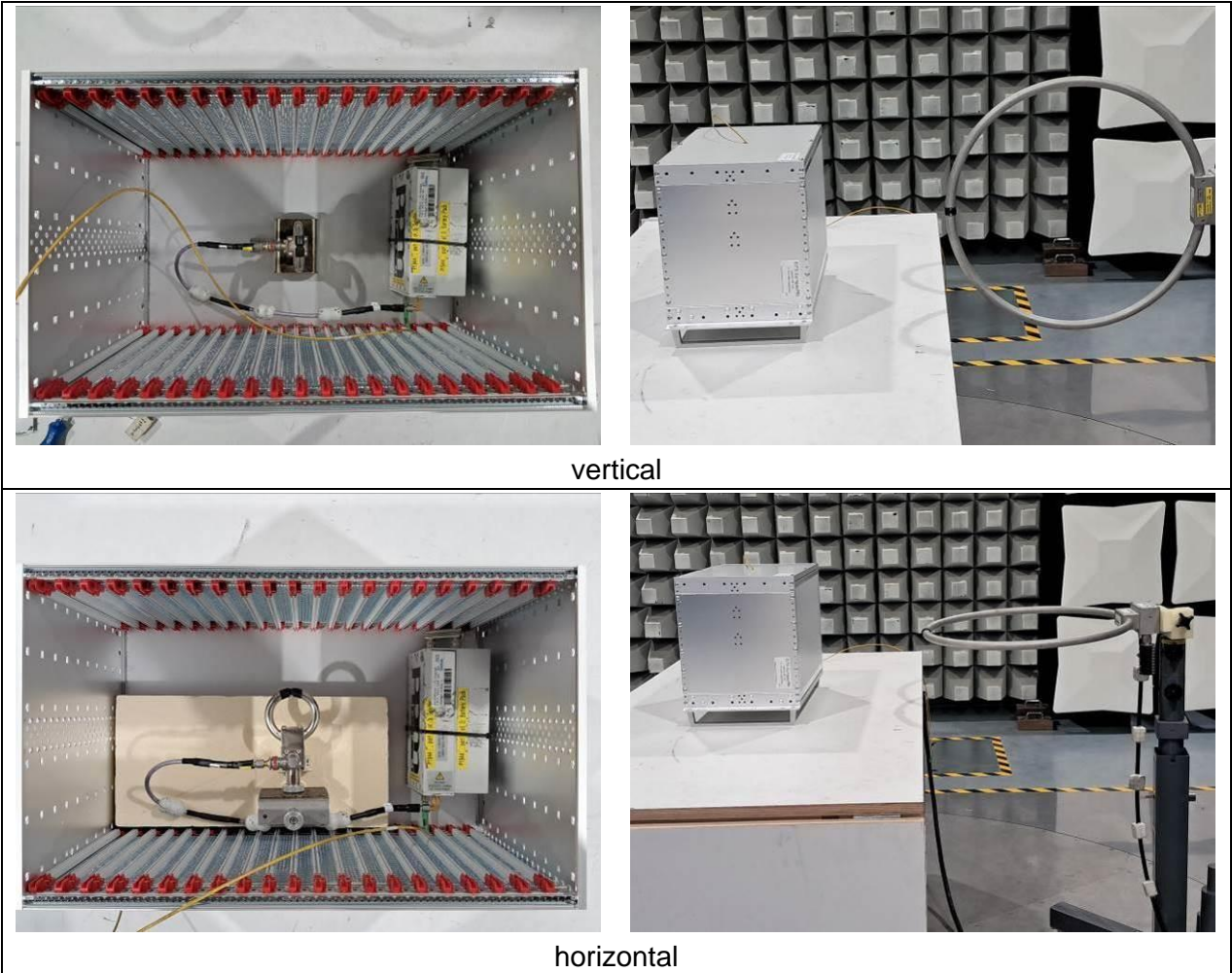

vertical

horizontal

Figure 6-5: test setup 0.01 – 30 MHz

The test report shall not be reproduced except in full without the written approval of the testing laboratory

6.2.5.4 Worst case

The figure below shows the worst case of shielding effectiveness, that means the lowest value of all positions and antenna polarisations at each frequency:

Shielding effectiveness 10 kHz - 30 MHz, Worst Case

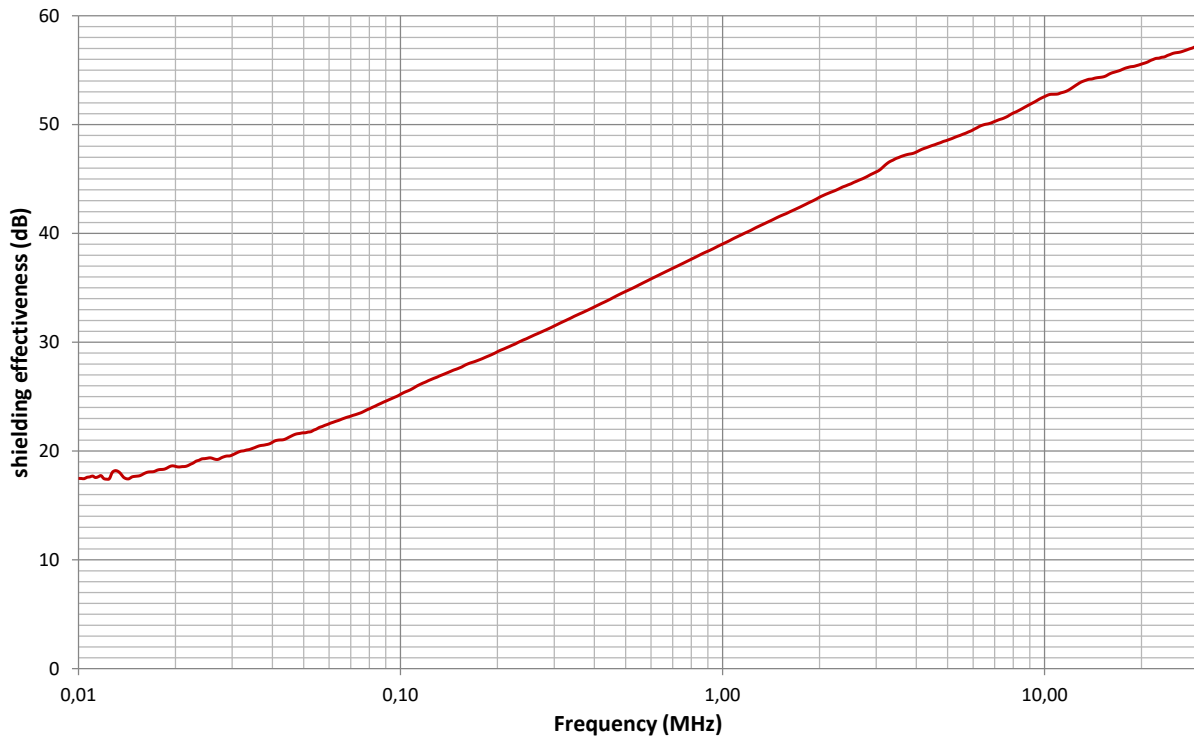

The test report shall not be reproduced except in full without the written approval of the testing laboratory

6.3 30 – 1000 MHz

Tested by : Pauli

Test date : 2024-04-18 Test location : EMC chamber No. 2

6.3.1 Test Setup

- Antenna distance = 2.00 m (between center of biconical ant. and reference point of Bilog.)
- Antenna height = 0.90 m
- no preamp in RX path for Reference measurements
- preamp P1182 (sonoma) in RX path for EUT measurements
- amplifier P2185 @ TX antenna
- 4dB attenuator at TX antenna
- 6dB attenuator @ RX antenna
- measuring bandwidth = 30Hz
- Number of points = 401
-

6.3.2 Measuring Equipment

ID	Measuring Instrument	Specification	Status	Due date
P1547	Network Analyzer	9 kHz - 4 GHz	cal	Mar 31, 2025
N0925	antenna cubic, 86 x 86 x 99 mm (122 mm incl. 90°-Adapter SMA)	Cubic Dipole Antenna	cnn	
P2506	coax cable, L = 0.5m	DC - 2 GHz, 0.56dB @ 2GHz, SMA, with ferrites	cnn	
P1944	Point2Point - AC Coupled Fibre Optic Link	2 kHz to 1.35 GHz, 0 dBm Input/Output	chk	Jan 31, 2025
P2578	coax cable 0.45 m, N - SMA	DC - 18 GHz, 0.8 dB @ 18 GHz	cnn	
P1182	preamplifier	9 kHz - 1000 MHz, 32dB gain, +10dBm	cal	Mar 31, 2026
P2517	coax cable, L = 0,5m, N	DC - 6GHz, 0,6dB@6GHz, N	cnn	
P1538	attenuator 6dB	6 dB; 5.5 W, SMA, DC to 18 GHz	chk	Dec 31, 2024
P2743	attenuator 4dB	Type N, 4 dB/ 5 W dc to 18 GHz	cal	Mar 31, 2026
P1950	Surface current blocking filter	DC-10 GHz, 2.6dB @ 10GHz, L = 1.4 m	chk	Sep 30, 2024
P1808	Surface current blocking filter	1 m / 11 ferrites, with polyester mesh, L = 1.4m	chk	Jun 30, 2026
P2158	LISN, Kfz - V-LISN 5µH	(5 µH+ 1 Ohm) 50 Ohm, 70 (100) A, 0.1 - 150MHz	cal	Mar 31, 2026

cal = Calibration, car = Calibration restricted use, chk = Check, chr = Check restricted use, cpu = Check prior to use, calchk = Calibration and check, ind = for indication only, cnn = Calibration not necessary, service = Wartung (Service), man = Maintenance, calservice = Calibration & Service, chkservice = Check & Service, calchkservice = Calibration & Check & Service, calinit = Initial Calibration only

The test report shall not be reproduced except in full without the written approval of the testing laboratory

6.3.3 Photographs of test setup for reference measurements

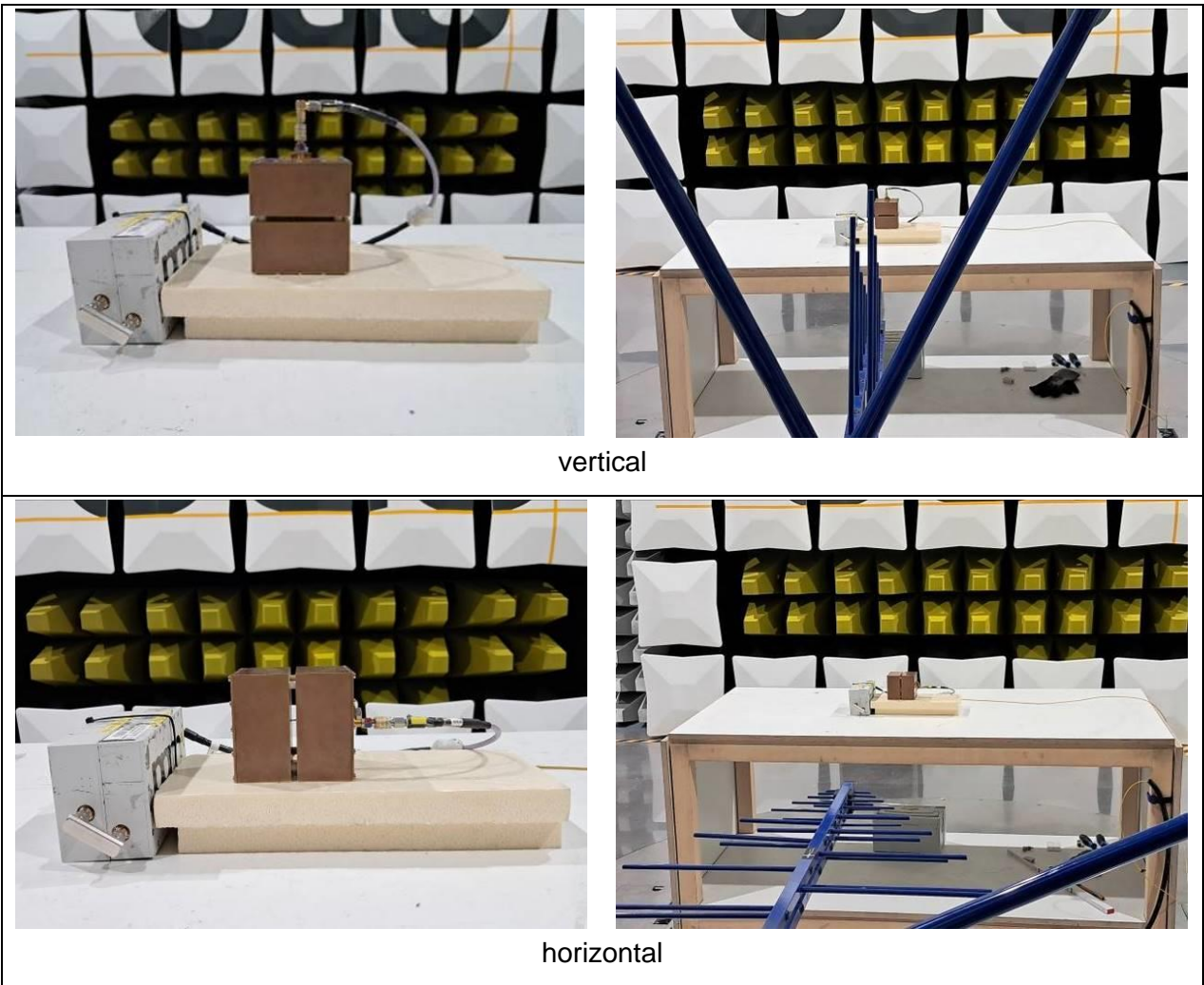

The test report shall not be reproduced except in full without the written approval of the testing laboratory

Figure 6-6: test setup reference measurements for position front/top

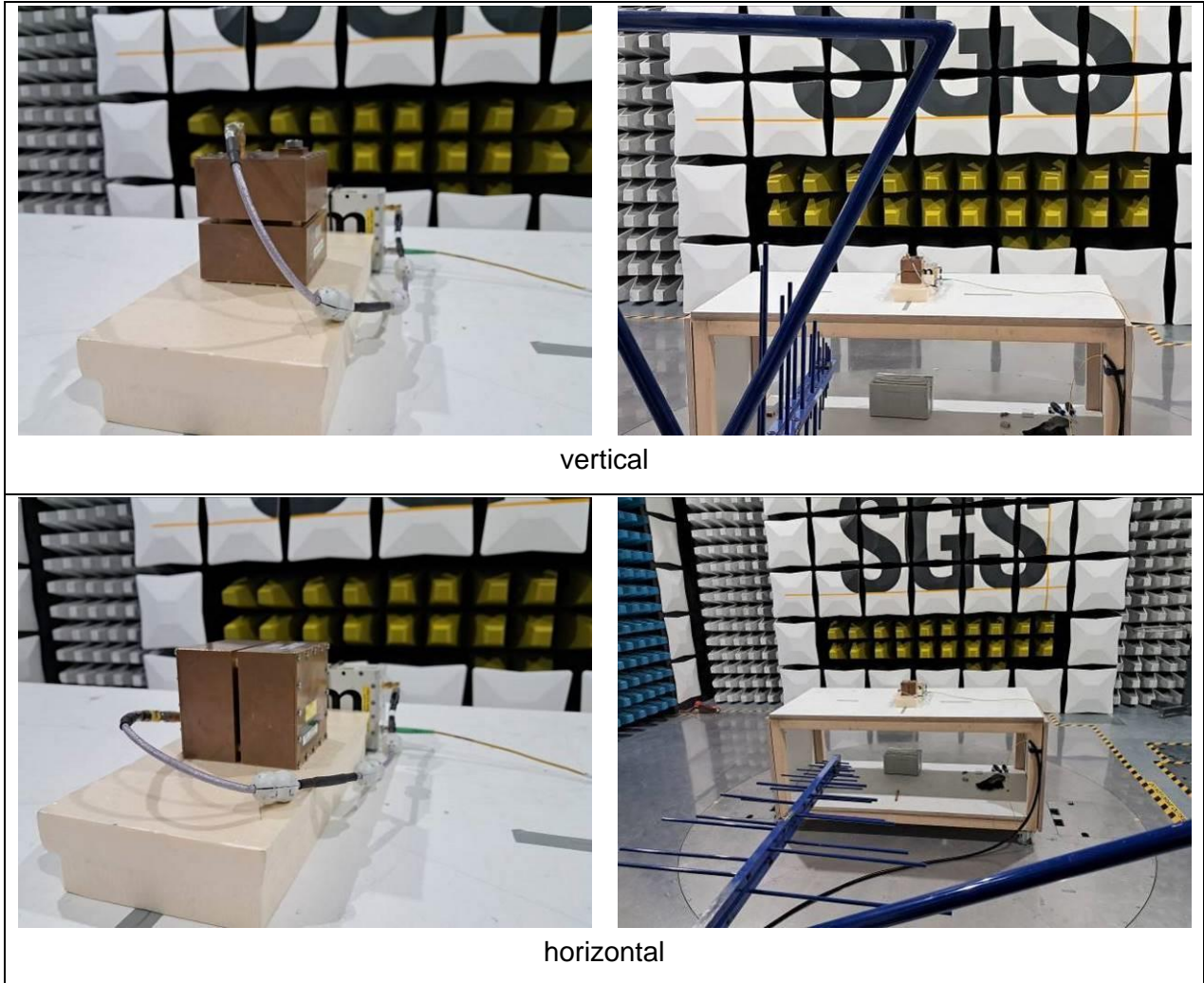
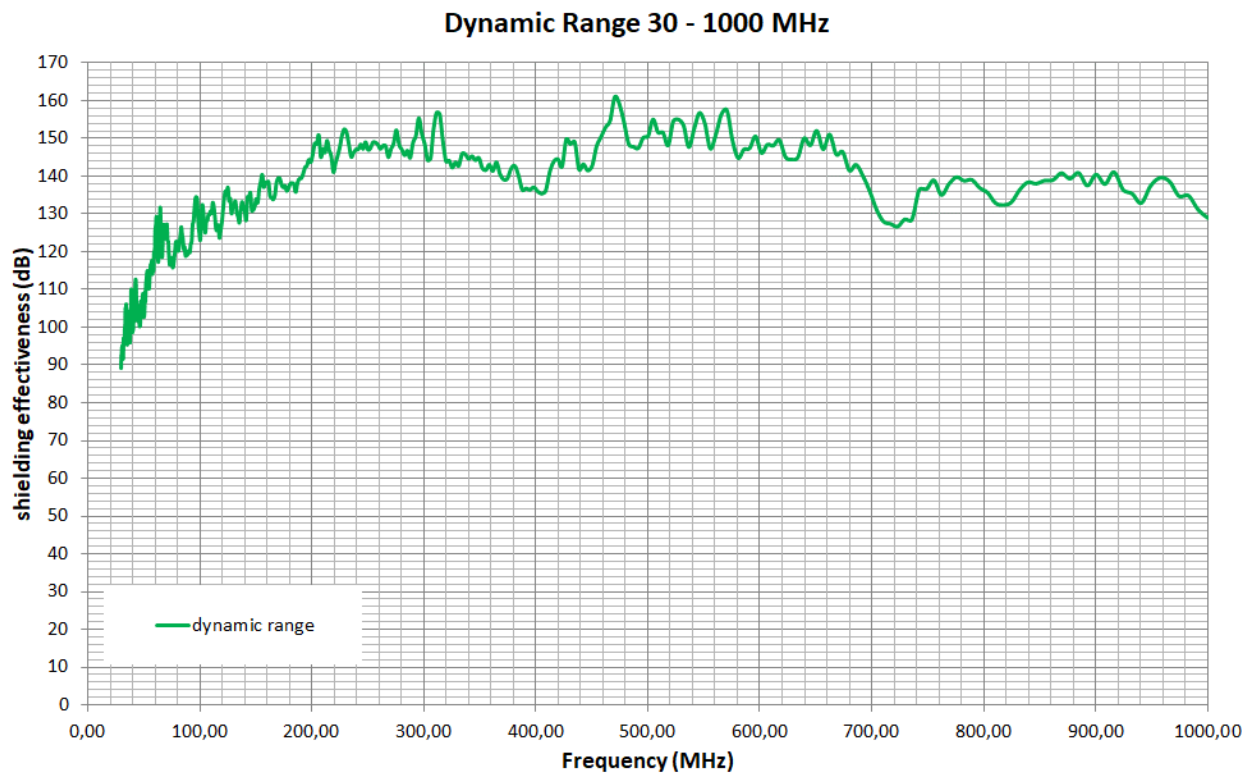

Figure 6-7: test setup reference measurements for position side

The test report shall not be reproduced except in full without the written approval of the testing laboratory

6.3.4 Dynamic range with Sonoma, BW = 10 Hz) (eut_0)



The test report shall not be reproduced except in full without the written approval of the testing laboratory

6.3.5 Test Results

6.3.5.1 Front

Shielding effectiveness 30 - 1000 MHz, Front

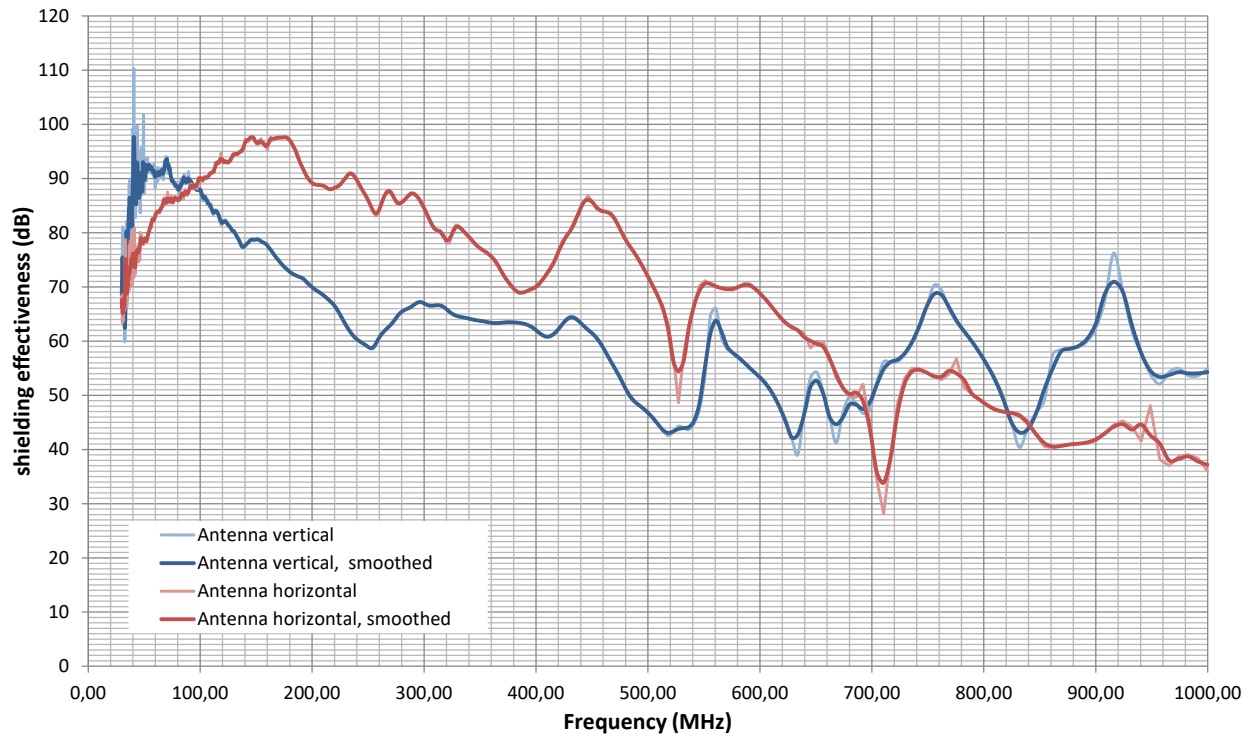

The test report shall not be reproduced except in full without the written approval of the testing laboratory

Photo documentation of the test set-up:

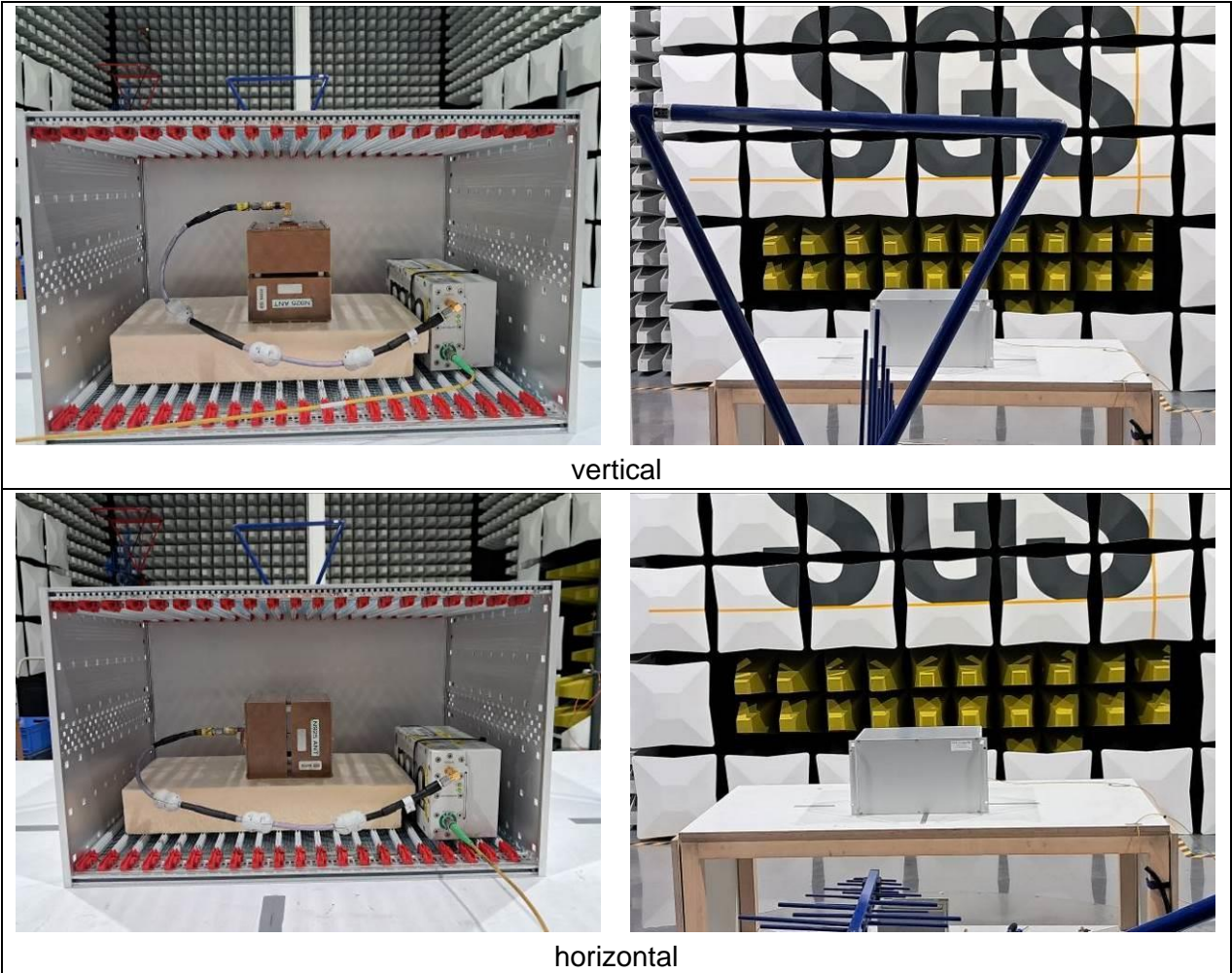

vertical

horizontal

Figure 6-8: test setup 30 – 1000 MHz

The test report shall not be reproduced except in full without the written approval of the testing laboratory

6.3.5.2 Side

Shielding effectiveness 30 - 1000 MHz, Side

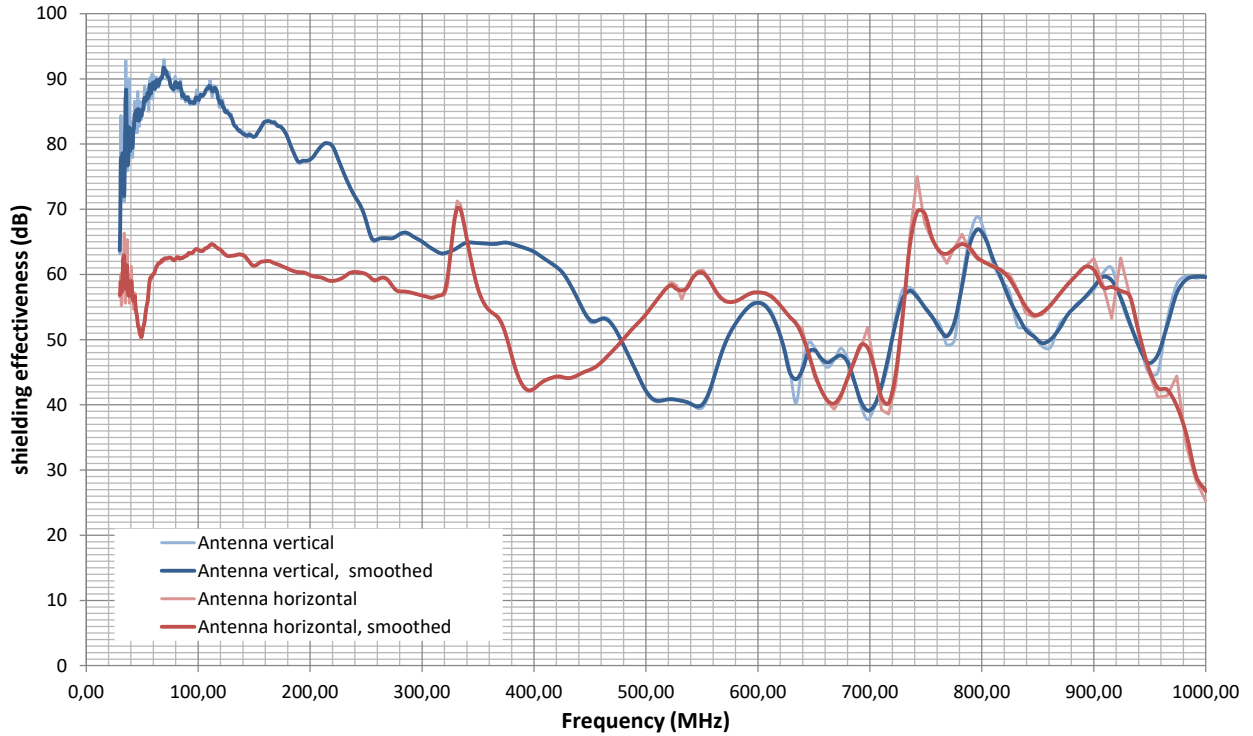

The test report shall not be reproduced except in full without the written approval of the testing laboratory

Photo documentation of the test set-up:



vertical

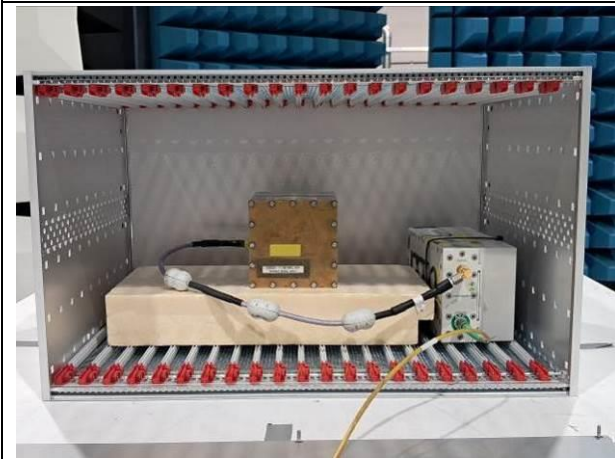

horizontal

Figure 6-9: test setup 30 – 1000 MHz

The test report shall not be reproduced except in full without the written approval of the testing laboratory

6.3.5.3 Top

Shielding effectiveness 30 - 1000 MHz, Top

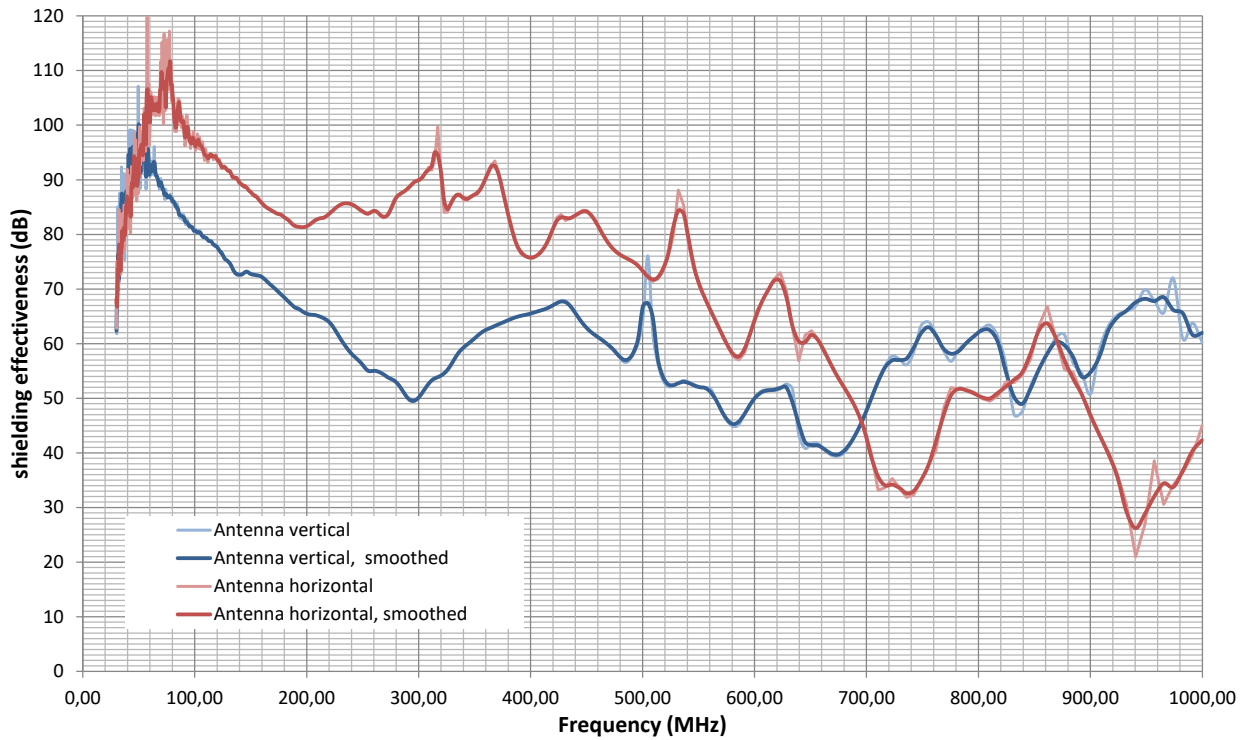

The test report shall not be reproduced except in full without the written approval of the testing laboratory

Photo documentation of the test set-up:

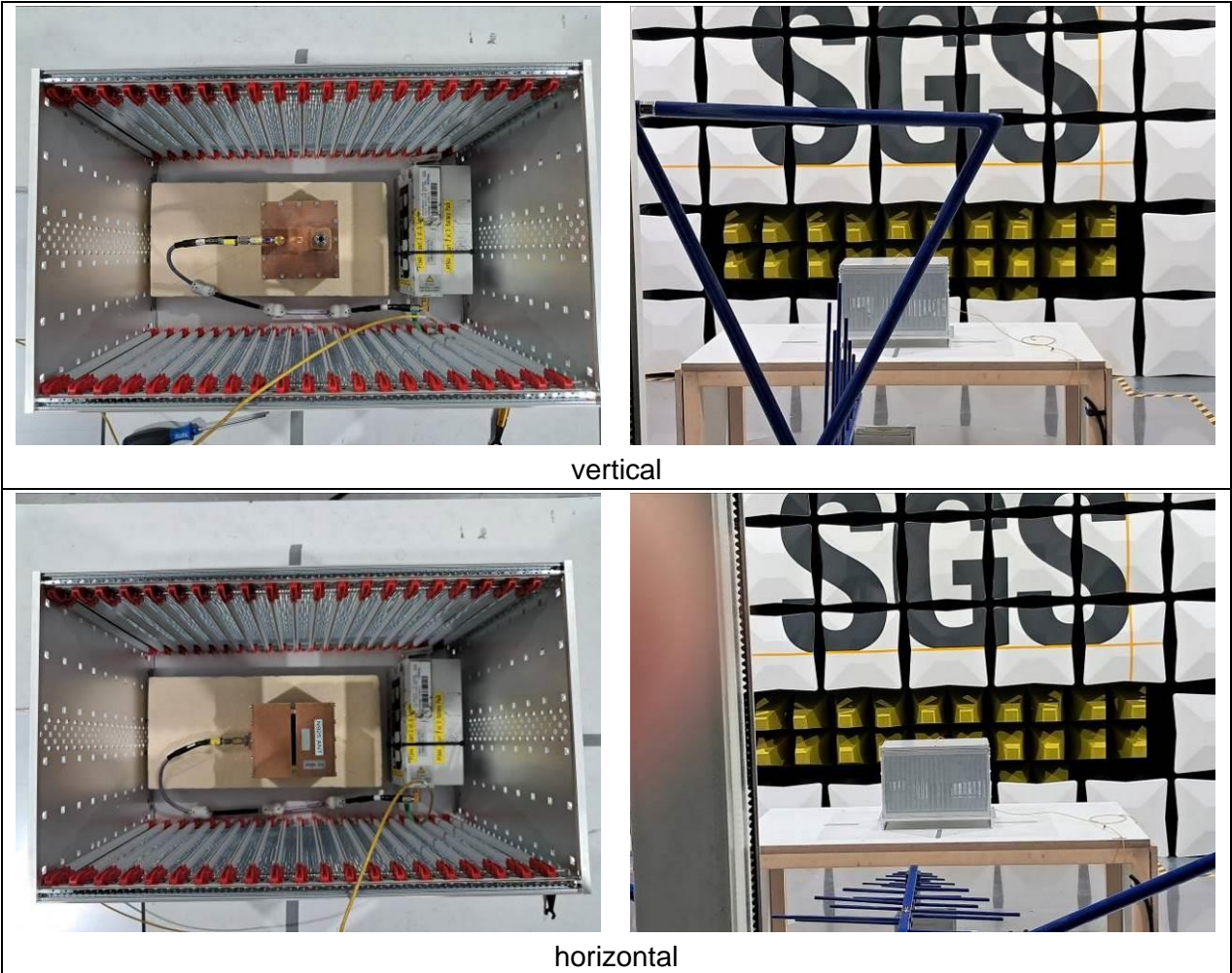

vertical

horizontal

Figure 6-10: test setup 30 – 1000 MHz

The test report shall not be reproduced except in full without the written approval of the testing laboratory

6.3.5.4 Worst case

The figure below shows the worst case of shielding effectiveness, that means the lowest value of all positions and antenna polarisations at each frequency:

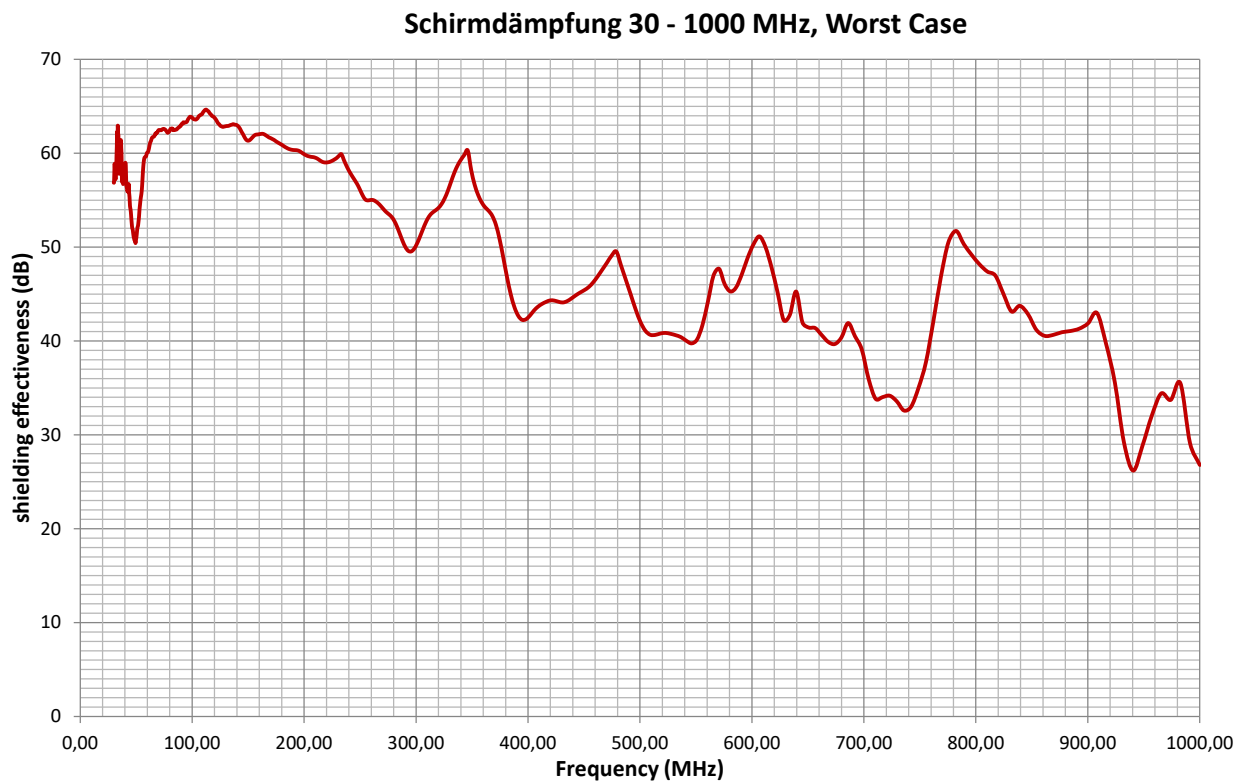

The test report shall not be reproduced except in full without the written approval of the testing laboratory

6.4 1 – 18 GHz

Tested by : Pauli

Test date : 2024-04-29

Test location : EMC chamber No. 7

6.4.1 Test Setup

- Antenna distance = 1.20 m (front to front)
- Antenna height = 1.07 m
- no preamp in RX path
- no preamp @ TX antenna
- no attenuator @ TX antenna
- no attenuator @ RX antenna
- measuring bandwidth = 30Hz
- Number of points = 801

6.4.2 Measuring Equipment

ID	Measuring Instrument	Specification	Status	Due date
P2781	Network analyzer	100 kHz - 20 GHz, Vector network analyzer, 2 ports, 20 GHz, 3.5 mm	cal	Sep 30, 2024
P0030	antenna (MZ3)	1 - 18 GHz	cal	Apr 30, 2026
P0961	antenna (MZ7)	1 - 18 GHz	cal	Apr 30, 2025
P2266	Tektronix SMA cable 0.5m		chk	Apr 30, 2025
P2652	coax cable 3m, ruggedized	DC-18GHz, 3.30dB@18GHz	chk	Aug 31, 2024
P1953	coax cable 2m, ruggedized	DC-18GHz, 2.5dB@18GHz	chk	Jun 30, 2026
P1949	coax cable 3m	DC-18GHz, 3.3dB@18GHz	chk	Jun 30, 2026
P2653	coax cable 5m, ruggedized	DC-18GHz, 5.45dB@18GHz	chk	Aug 31, 2024
P1650	preamplifier (MZ3)	0.1 - 20GHz, gain ca. 28dB	cal	Mar 31, 2025
P2429	EMC chamber 7	dimensions (gross): (L x B x H): 6,1 x 5,5 x 3,6 m; frequency range 10 kHz - 20 GHz	chk	

cal = Calibration, car = Calibration restricted use, chk = Check, chr = Check restricted use, cpu = Check prior to use, calchk = Calibration and check, ind = for indication only, cnn = Calibration not necessary, service = Wartung (Service), man = Maintenance, calservice = Calibration & Service, chkservice = Check & Service, calchkservice = Calibration & Check & Service, calinit = Initial Calibration only

The test report shall not be reproduced except in full without the written approval of the testing laboratory

6.4.3 Photographs of test setup for reference measurements

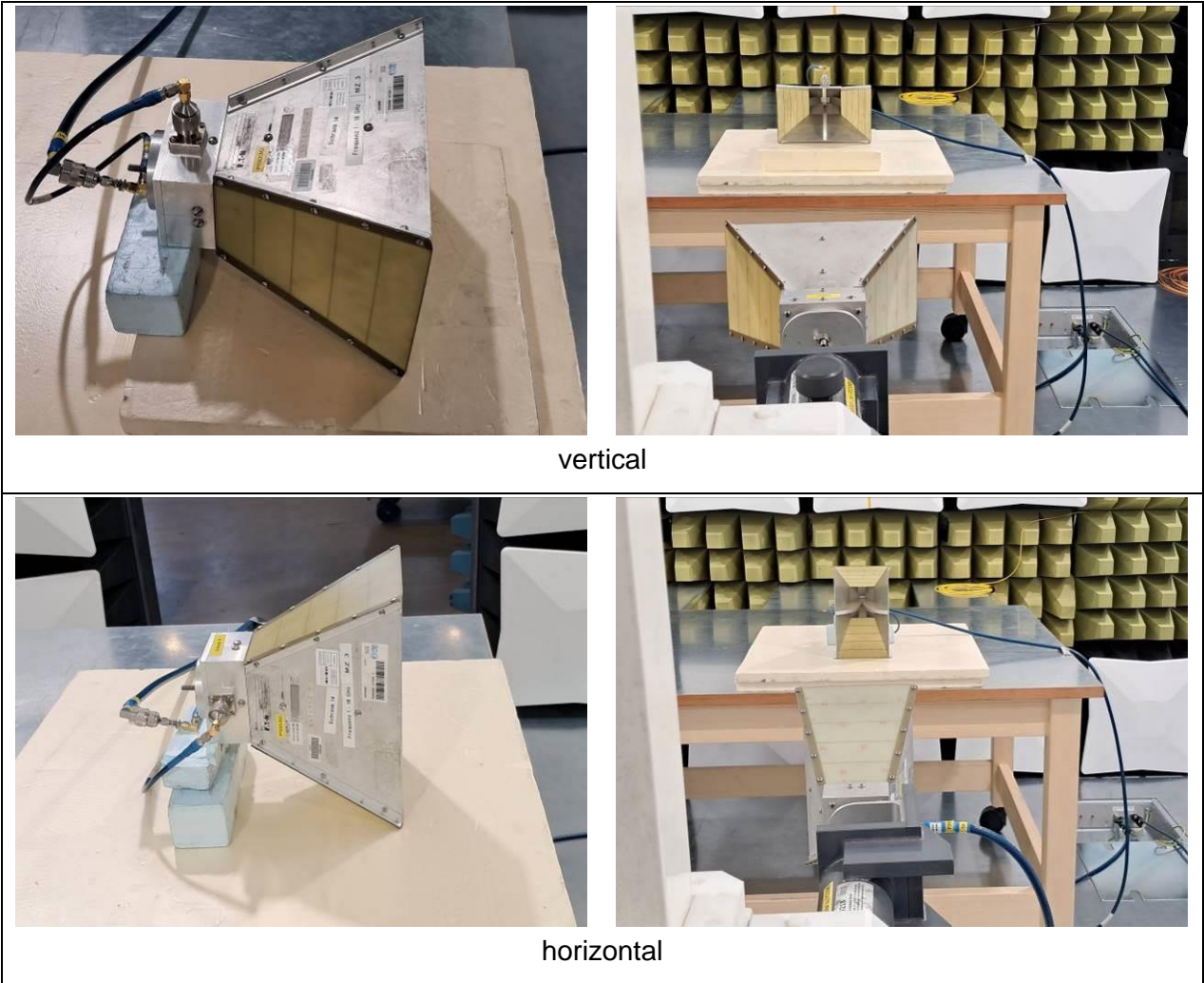

vertical

horizontal

Figure 6-11: test setup reference measurements

The test report shall not be reproduced except in full without the written approval of the testing laboratory

6.4.4 Dynamic range

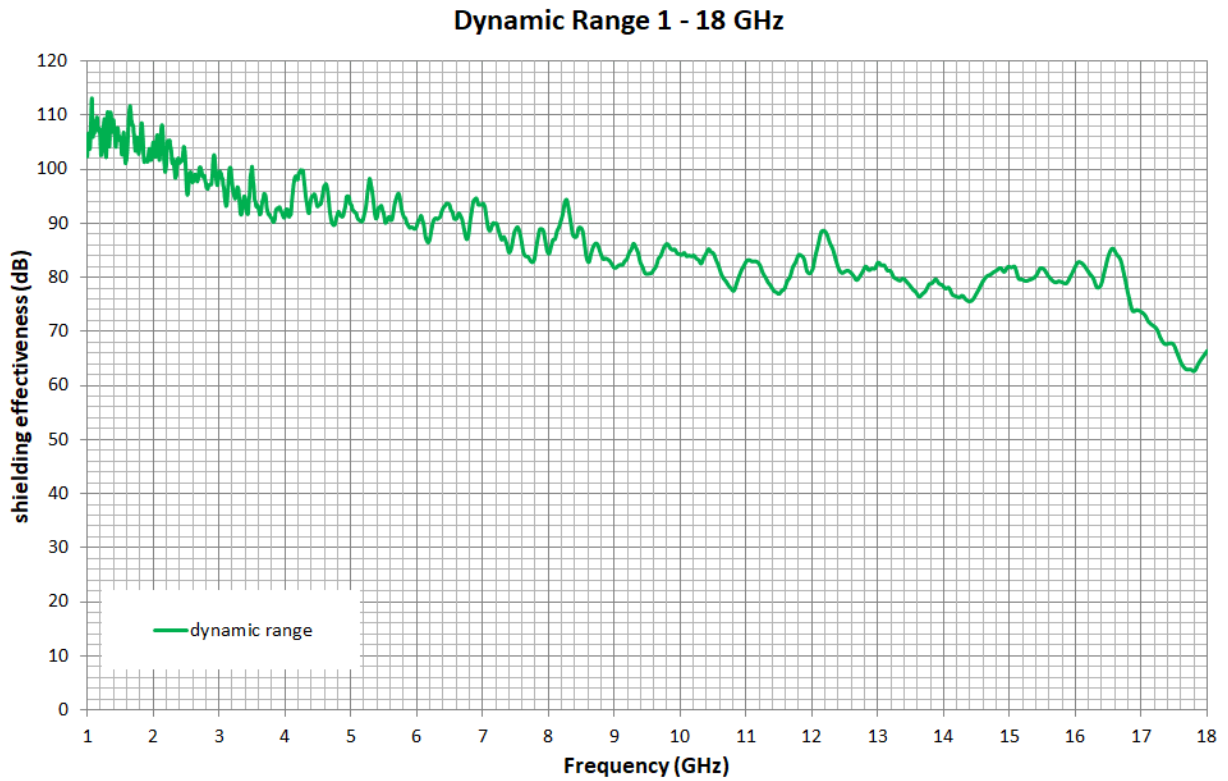

The test report shall not be reproduced except in full without the written approval of the testing laboratory

6.4.5 Test Results

6.4.5.1 Front

Due to the dimensions of EUT it was not possible to place the RX antenna inside the EUT in horizontal polarisation. Therefore, only a measurement in vertical polarisation could be done.

Shielding effectiveness 1 - 18 GHz, Front

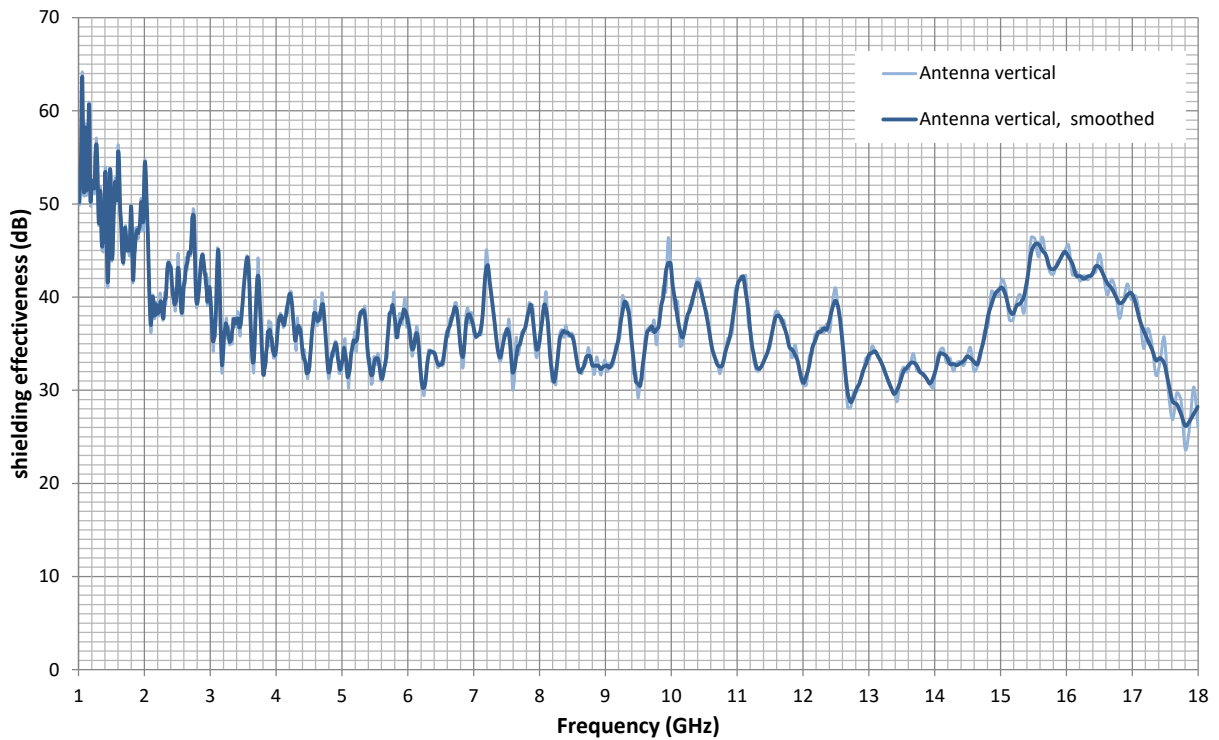

The test report shall not be reproduced except in full without the written approval of the testing laboratory

Photo documentation of the test set-up:

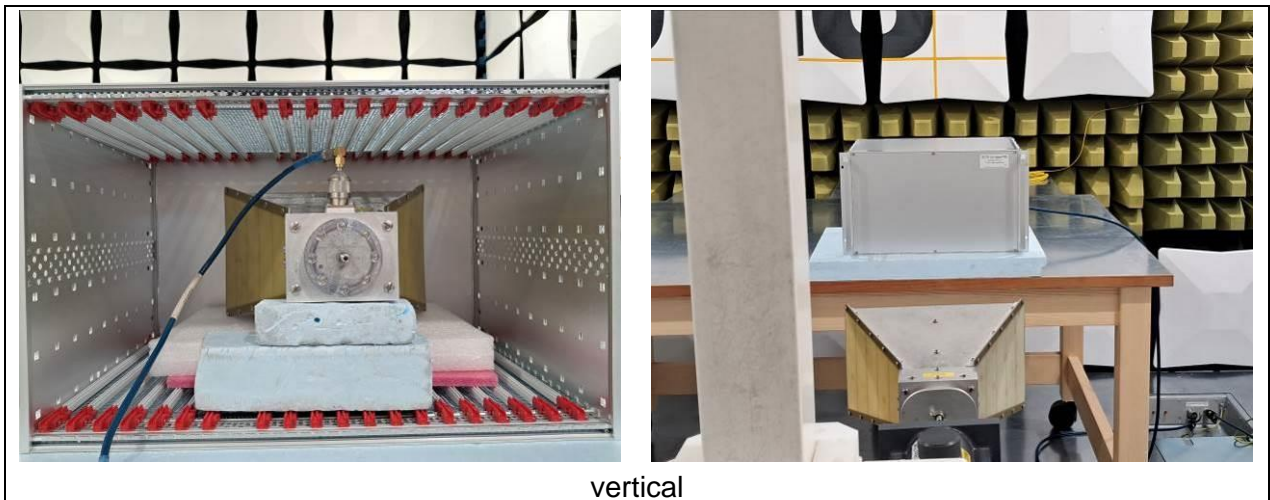

vertical

Figure 6-12: test setup 1 – 18 GHz

6.4.5.2 Side

Shielding effectiveness 1 - 18 GHz, Side

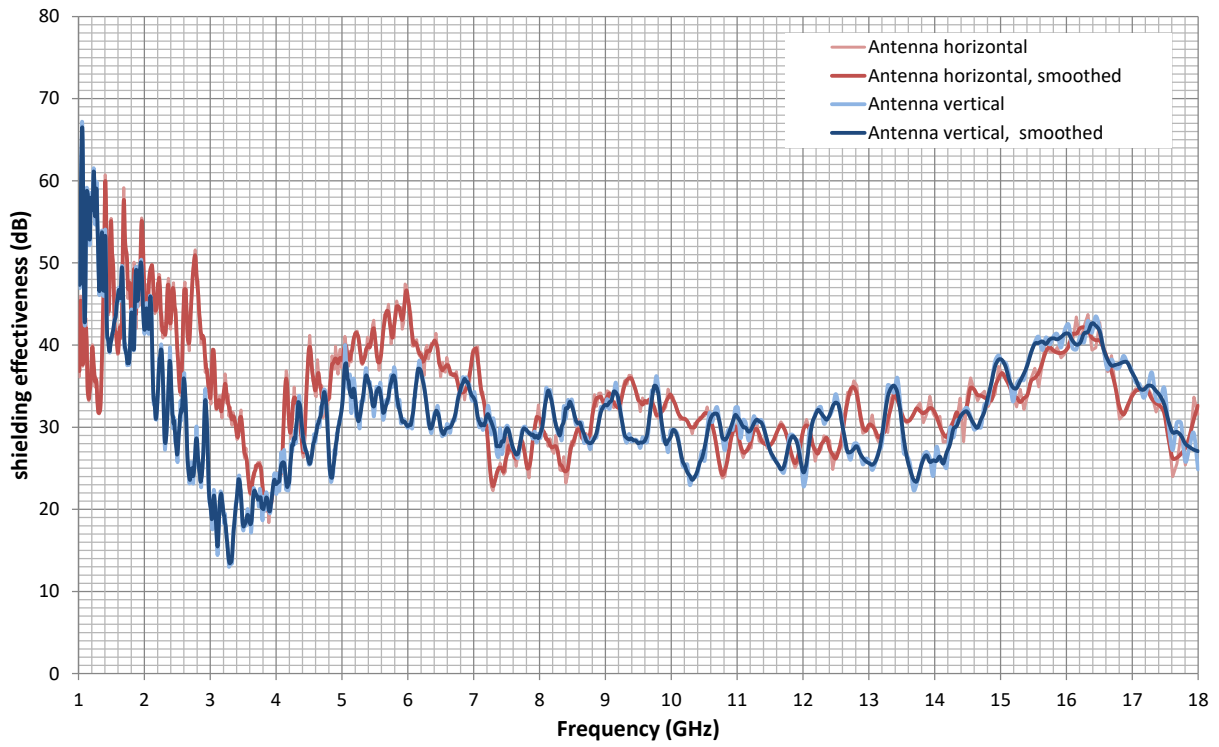

The test report shall not be reproduced except in full without the written approval of the testing laboratory

Photo documentation of the test set-up:

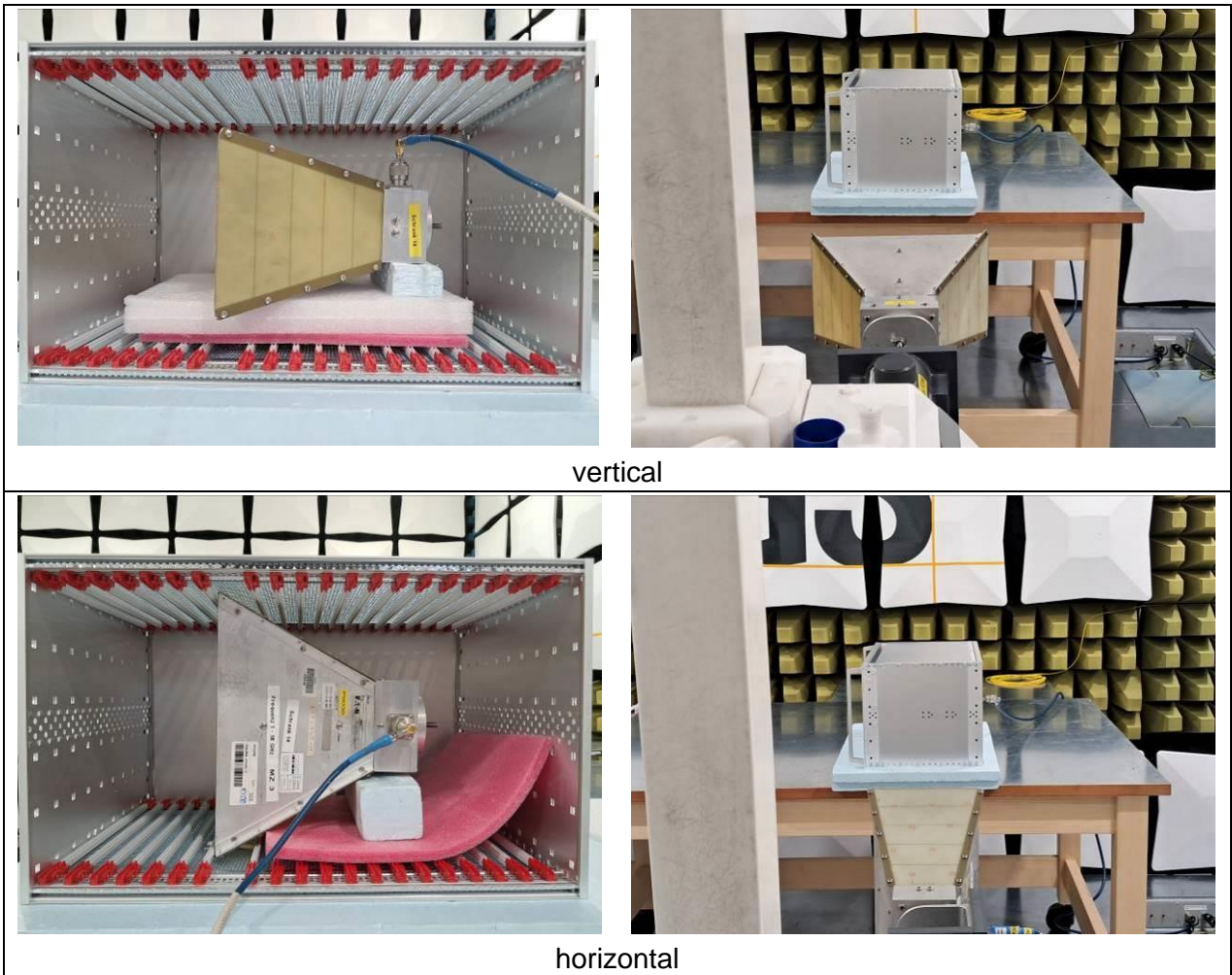
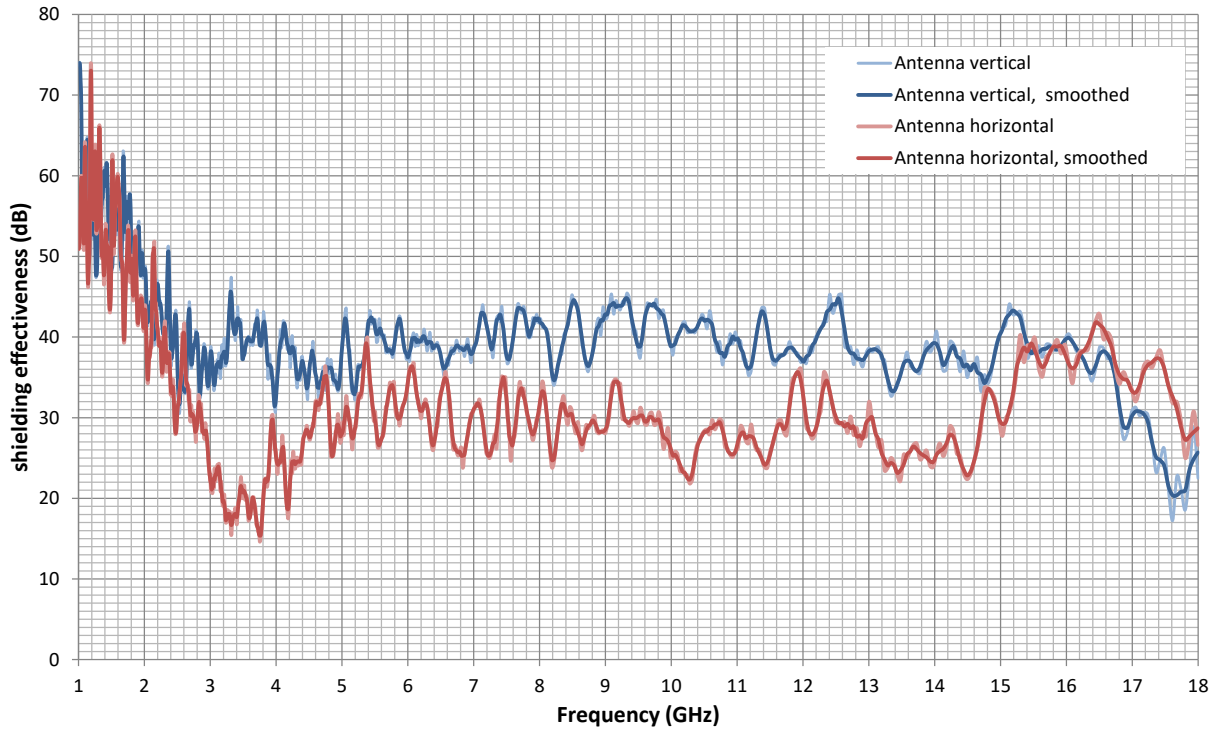

Figure 6-13: test setup 1 – 18 GHz

The test report shall not be reproduced except in full without the written approval of the testing laboratory

6.4.5.3 Top

Shielding effectiveness 1 - 18 GHz, Top



The test report shall not be reproduced except in full without the written approval of the testing laboratory

Photo documentation of the test set-up:



vertical

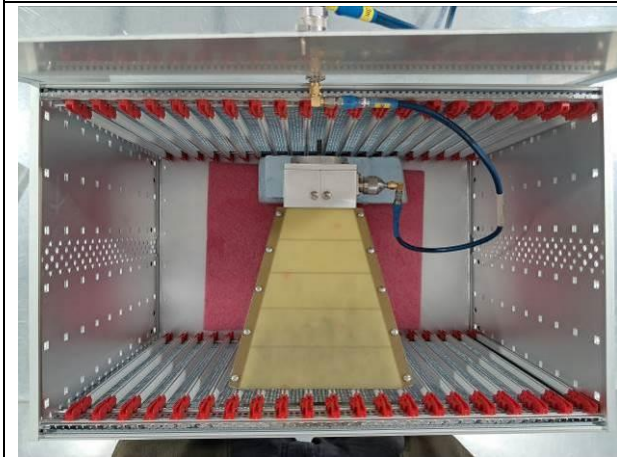

horizontal

Figure 6-14: test setup 1 – 18 GHz

The test report shall not be reproduced except in full without the written approval of the testing laboratory

6.4.5.4 Worst case

The figure below shows the worst case of shielding effectiveness, that means the lowest value of all positions and antenna polarisations at each frequency:

Shielding effectiveness 1 - 18 GHz, Worst Case

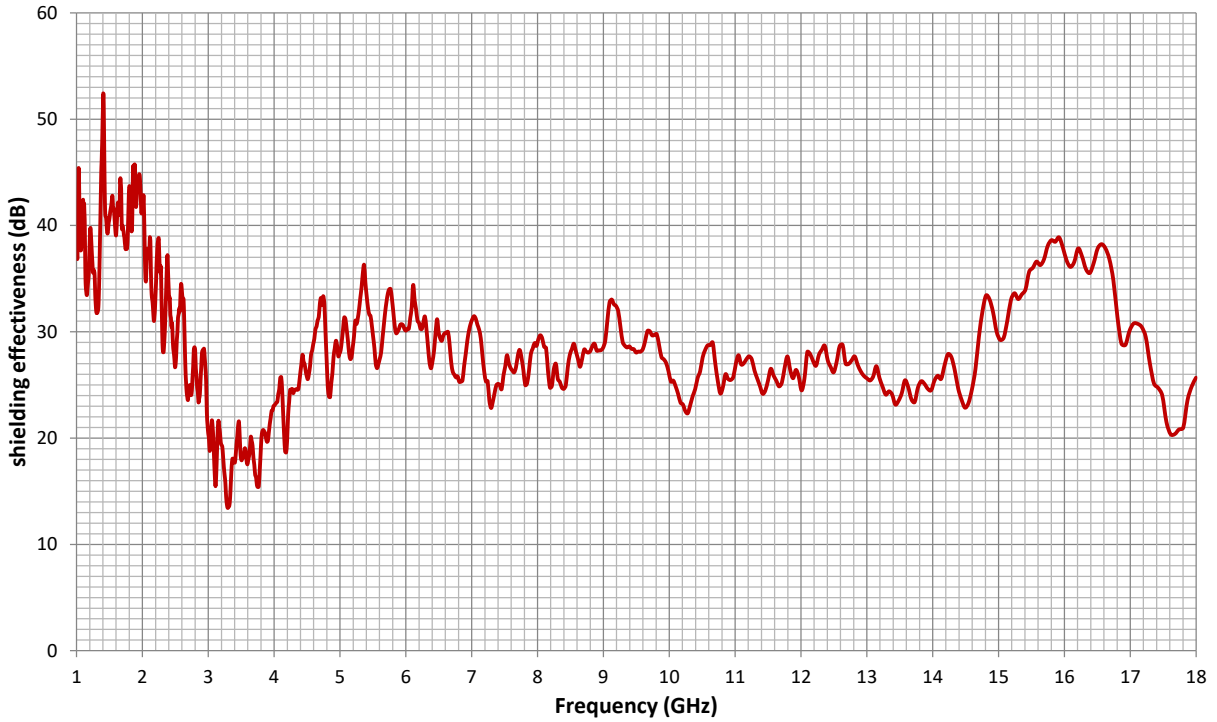

The test report shall not be reproduced except in full without the written approval of the testing laboratory

6.5 18 – 40 GHz (single frequencies only)

Tested by : Andreas Pauli

Test date : 2024-04-30 Test location : EMC chamber No. 7

6.5.1 Setup

6.5.2 Test Setup

- Antenna distance = 0,80 m (front to front)
- Antenna height = 1.07 m
- no preamp in RX path
- no amplifier @ TX antenna
- no attenuator at TX antenna
- no attenuator @ RX antenna
- measuring bandwidth = 120 kHz
- measuring time = 100 ms
- Detector = Average
- Internal Preamplifier = ON

6.5.3 Measuring Equipment

ID	Measuring Instrument	Specification	Status	Due date
P0567	signal generator	10 MHz - 20 GHz	cal	Mar 31, 2027
P2797	EMI receiver (MZ8)	Frequency range: 1 Hz to 44 GHz	cal	Nov 30, 2024
P1340	antenna (18 - 40 GHz)	18- 40 GHz	cal	May 31, 2026
P1148	antenna (horn 18 - 40GHz)	18 - 40 GHz	cal	May 31, 2024
P2738	coax cable 5m	DC- 40GHz, = 90 dB (up to 18 GHz)	cal	Mar 31, 2026
P1227	frequency doubler 13-20GHz	13 - 20GHz (in), 26 - 40GHz (out)	cnn	
P1949	coax cable 3m	DC-18GHz, 3.3dB@18GHz	chk	Jun 30, 2026
P2266	Tektronix SMA cable 0.5m		chk	Apr 30, 2025

cal = Calibration, car = Calibration restricted use, chk = Check, chr = Check restricted use, cpu = Check prior to use, calchk = Calibration and check, ind = for indication only, cnn = Calibration not necessary, service = Wartung (Service), man = Maintenance, calservice = Calibration & Service, chkservice = Check & Service, calchkservice = Calibration & Check & Service, calinit = Initial Calibration only

The test report shall not be reproduced except in full without the written approval of the testing laboratory

6.5.4 Photographs of test setup

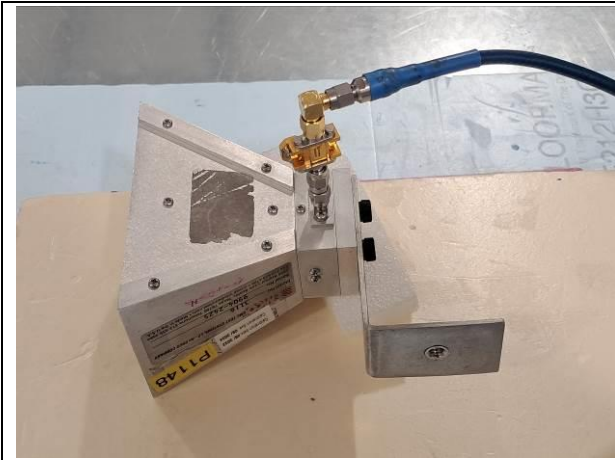

vertical

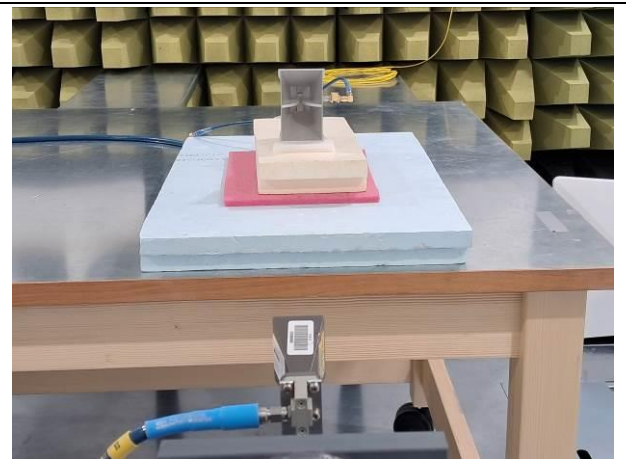

horizontal

Figure 6-15: test setup, 18 – 40 GHz

The test report shall not be reproduced except in full without the written approval of the testing laboratory

6.5.5 Test Results

6.5.5.1 Front

6.5.5.1.1 Horizontal

Frequency in GHz	measured Levels in dB μ V		Noise Level	Dynamic Range	Shielding effectiveness
	Reference	EUT			
20,0	67,5	30,3	-8,3	75,8	37,2
24,0	68,1	32,0	-8,0	76,1	36,1
28,0	67,2	18,1	-7,5	74,7	49,1
32,0	63,6	19,9	-7,2	70,8	43,7
36,0	62,5	20,9	-6,3	68,8	41,6
40,0	51,1	0,3	-6,1	57,2	50,8

Photo documentation of the test set-up:



Figure 6-16: test setup horizontal, 18 – 40 GHz

The test report shall not be reproduced except in full without the written approval of the testing laboratory

6.5.5.1.2 Vertical

Frequency in GHz	measured Levels in dB μ V		Noise Level	Dynamic Range	Shielding effectiveness
	Reference	EUT			
20,0	67,5	41,6	-8,3	75,8	25,9
24,0	68,1	33,7	-8,0	76,1	34,4
28,0	66,9	33,0	-7,5	74,4	33,9
32,0	64,4	26,3	-7,2	71,6	38,1
36,0	62,4	19,5	-6,3	68,7	42,9
40,0	48,5	-2,2	-6,1	54,6	50,7

Photo documentation of the test set-up:

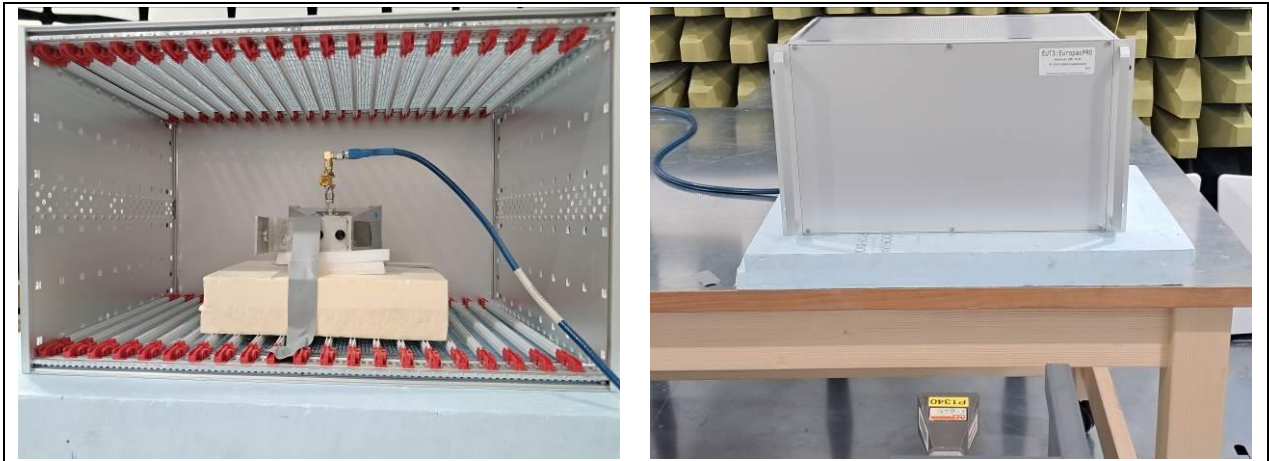

Figure 6-17: test setup vertical, 18 – 40 GHz

The test report shall not be reproduced except in full without the written approval of the testing laboratory

6.5.5.2 Side

6.5.5.2.1 Horizontal

Frequency in GHz	measured Levels in dB μ V		Noise Level	Dynamic Range	Shielding effectiveness
	Reference	EUT			
20,0	67,5	41,9	-8,3	75,8	25,6
24,0	68,1	39,4	-8,0	76,1	28,7
28,0	67,2	38,4	-7,5	74,7	28,8
32,0	63,6	35,2	-7,2	70,8	28,4
36,0	62,5	35,8	-6,3	68,8	26,7
40,0	51,1	26,3	-6,1	57,2	24,8

Photo documentation of the test set-up:



Figure 6-18: test setup horizontal, 18 – 40 GHz

The test report shall not be reproduced except in full without the written approval of the testing laboratory

6.5.5.2.2 Vertical

Frequency in GHz	measured Levels in dB μ V		Noise Level	Dynamic Range	Shielding effectiveness
	Reference	EUT			
20,0	67,5	38,5	-8,3	75,8	29,0
24,0	68,1	33,5	-8,0	76,1	34,6
28,0	66,9	29,5	-7,5	74,4	37,4
32,0	64,4	23,7	-7,2	71,6	40,7
36,0	62,4	32,6	-6,3	68,7	29,8
40,0	48,5	19,5	-6,1	54,6	29,0

Photo documentation of the test set-up:

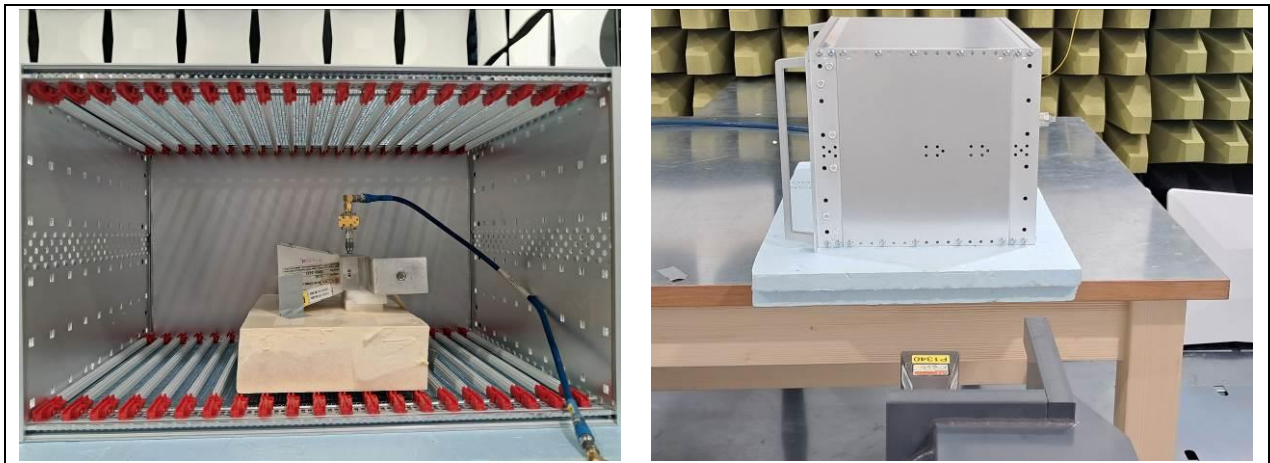

Figure 6-19: test setup vertical, 18 – 40 GHz

The test report shall not be reproduced except in full without the written approval of the testing laboratory

6.5.5.3 Top

6.5.5.3.1 Horizontal

Frequency in GHz	measured Levels in dB μ V		Noise Level	Dynamic Range	Shielding effectiveness
	Reference	EUT			
20,0	67,5	49,0	-8,3	75,8	18,5
24,0	68,1	35,2	-8,0	76,1	32,9
28,0	67,2	36,8	-7,5	74,7	30,4
32,0	63,6	30,7	-7,2	70,8	32,9
36,0	62,5	40,3	-6,3	68,8	22,2
40,0	51,1	35,2	-6,1	57,2	15,9

Photo documentation of the test set-up:

The test report shall not be reproduced except in full without the written approval of the testing laboratory



Figure 6-20: test setup horizontal, 18 – 40 GHz

6.5.5.3.2 Vertical

24,0	68,1	36,4	-8,0	76,1	31,7
28,0	66,9	44,3	-7,5	74,4	22,6
32,0	64,4	36,5	-7,2	71,6	27,9
36,0	62,4	33,5	-6,3	68,7	28,9
40,0	48,5	29,5	-6,1	54,6	19,0

Photo documentation of the test set-up:

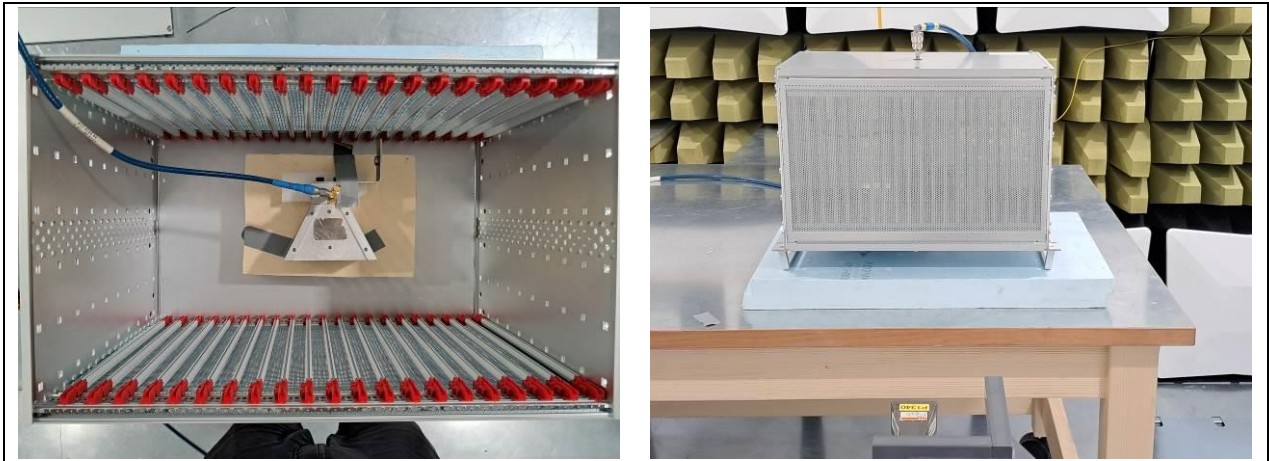

Figure 6-21: test setup vertical, 18 – 40 GHz

The test report shall not be reproduced except in full without the written approval of the testing laboratory

6.5.5.4 Worst case

The table below shows the worst case of shielding effectiveness, that means the lowest value of all positions and antenna polarisations at each frequency:

Frequency in GHz	Shielding effectiveness in dB
20,0	18,5
24,0	28,7
28,0	22,6
32,0	27,9
36,0	22,2
40,0	15,9

7 Disclaimer

This document is issued by the Company subject to its General Conditions of Service (www.sgsgroup.de/agb). Attention is drawn to the limitations of liability, indemnification and jurisdictional issues established therein.

This document is an original. If the document is submitted digitally, it is to be treated as an original within the meaning of UCP 600.

Any holder of this document is advised that information contained hereon reflects the Company's findings at the time of its intervention only and within the limits of client's instructions, if any. The Company's sole responsibility is to its Client and this document does not exonerate parties to a transaction from exercising all their rights and obligations under the transaction documents. Any unauthorized alteration, forgery or falsification of the content or appearance of this document is unlawful and offenders may be prosecuted to the fullest extent of the law.

End of Test Report

The test report shall not be reproduced except in full without the written approval of the testing laboratory