



Austrian Institute of Construction Engineering
Schenkenstrasse 4 | T+43 1 533 65 50
1010 Vienna | Austria | F+43 1 533 64 23
www.oib.or.at | mail@oib.or.at



European Technical Assessment

ETA-17/0845
of 20.11.2017

General part

Technical Assessment Body issuing the European Technical Assessment

Österreichisches Institut für Bautechnik (OIB)
Austrian Institute of Construction Engineering

Trade name of the construction product

FBS-EN Foam Barrier System

Product family to which the construction product belongs

Fire Stopping and Fire Sealing Products:
Penetration Seals

Manufacturer

fischerwerke GmbH & Co. KG
Klaus-Fischer-Straße 1
72178 Waldachtal
GERMANY

Manufacturing plant

fischer SystemTec GmbH
Plant Z

This European Technical Assessment contains

36 pages including Annexes A-1 to J-1 which form an integral part of this assessment

This European Technical Assessment is issued in accordance with Regulation (EU) No 305/2011, on the basis of

Guideline for European technical approval for „Fire Stopping and Fire Sealing Products”, ETAG 026 Part 2: „Penetration Seals”, edition August 2011, used as European Assessment Document (EAD)

Specific parts

1 Technical description of the product

“FBS-EN Foam Barrier System” is a kit to be used as a mixed penetration seal or cable penetration seal based on the following components and additional insulations.

Components of “FBS-EN Foam Barrier System”	Characteristics
FBS-EN Foam Barrier	Product in cartridges on the basis of polyurethane with intumescent fire protection additives. After application it reacts and increases its volume
FIB fischer Insulating Bandage	Intumescent wrap on the basis of butyl rubber with intumescent fire protection additives and glass fabric reinforcement
FBB-EN Firestop Block	Block-shaped intumescent elastic product (can be vacuum-packed) on the basis of polyurethane with intumescent fire protection additives

Insulations (additional components)	Characteristics
Prefabricated pipe shells	Prefabricated pipe shells according to EN 14303 made from stone wool with classification A _{2L} -s ₁ ,d ₀ or A _{1L} according to EN 13501-1, a minimum density of 90 kg/m ³ and a melting point > 1000 °C according to DIN 4102-17 (e.g. „Rockwool 800” from manufacturer „Deutsche Rockwool Mineralwoll GmbH & Co. OHG”)
AF/Armaflex	Closed cell, flexible elastomeric foam (FEF) insulation in form of (slotted) tubes (can be provided with a self-adhesive device) with classification B _L -s ₃ ,d ₀ – including „Armaflex Kleber 520” (Armaflex Adhesive 520) – according to EN 13501-1 from manufacturer „Armacell GmbH”
AF/Armaflex Band selbstklebend (AF/Armaflex self-adhesive tape)	Closed cell, flexible elastomeric foam (FEF) insulation in form of tapes with a self-adhesive device with classification B-s ₃ ,d ₀ according to EN 13501-1 from manufacturer „Armacell GmbH”
Armaflex Kleber 520 (Armaflex Adhesive 520)	Polychlorene-based adhesive, free from aromatic compounds (special adhesive for processing of all flexible Armaflex insulating material – except „HT/Armaflex”) from manufacturer „Armacell GmbH”

2 Specification of the intended use(s) in accordance with the applicable European Assessment Document (hereinafter EAD)

2.1 Intended use

“FBS-EN Foam Barrier System” is intended to be used as a mixed penetration seal or cable penetration seal to temporarily or permanently reinstate the fire resistance performance of flexible wall constructions, rigid wall constructions and rigid floor constructions where they have been provided with apertures which are penetrated by various cables, conduits / tubes, metal pipes, plastic pipes and cable support constructions (perforated or non-perforated steel cable trays and steel ladders).

The thickness of the penetration seal has to be minimum 144 mm or 200 mm (mixed penetration seal; depending on the fire resistance classification; see Annex F-1 of the ETA) and minimum 100 mm, 144 mm, 200 mm or 250 mm (cable penetration seal; depending on the fire resistance classification; see Annex J-1 of the ETA).

The maximum opening size of the penetration seal has to comply with the dimensions as specified in the following table.

Blank penetration seals with maximum opening sizes as specified in the following table have been tested.

“FBS-EN Foam Barrier System” can be installed only in the types of separating elements as specified in the following table.

Separating element	Construction	a) Maximum opening size of the penetration seal (width x height) b) Minimum thickness of the penetration seal
Flexible walls	<ul style="list-style-type: none"> > Steel studs or timber studs lined on both faces with minimum 2 layer of boards (minimum thickness 12,5 mm) with classification A2-s1,d0 or A1 according to EN 13501-1 > For timber stud walls there shall be a minimum distance of 100 mm of the penetration seal to any timber stud. The cavity between the penetration seal and the timber stud has to be closed with minimum 100 mm of insulation with classification A1 or A2 according to EN 13501-1 > Minimum thickness 94 mm > Classification according to EN 13501-2: ≥ EI 60 > This European Technical Assessment does not cover sandwich panel constructions and flexible walls where the lining does not cover studs on both sides. Penetrations in such constructions shall be tested on a case by case basis 	<p><u>Mixed penetration seal (see Annex B-1 of the ETA):</u> a) 450 x 500 [mm] b) 144 mm / 200 mm</p> <p><u>Cable penetration seal (see Annex G-1 of the ETA):</u> a) 270 x 270 [mm] / Ø 300 mm b) 100 mm / 144 mm / 200 mm / 250 mm</p>

electronic copy

Penetrating element	Construction characteristics of the penetrating element in “FBS-EN Foam Barrier System” in flexible walls, rigid walls and rigid floors
Cable support constructions	<ul style="list-style-type: none">> Steel cable trays (perforated or non-perforated)> Steel ladders> Steel cable trays (perforated or non-perforated) and steel ladders with organic coatings shall at least be classified A2-s1,d0 according to EN 13501-1

2.2 Use category

“FBS-EN Foam Barrier System” is intended for internal use with humidity equal to or higher than 85 % RH, excluding temperatures below 0 °C³, without exposure to rain or UV, and can therefore – according to ETAG 026-Part 2 clause 2.4.12.1.3.3 – be categorized as Type Z₁. Since the requirements for Type Z₁ are met, also the requirements for Type Z₂ are fulfilled.

Although a penetration seal is intended for indoor applications only, the construction process may result in it being subjected to more exposed conditions for a period before the building envelope is closed. For this case provisions shall be made to protect temporarily exposed penetration seals according to the ETA-holder’s installation instructions.

2.3 Working life

The provisions made in this European Technical Assessment are based on an assumed working life of “FBS-EN Foam Barrier System” of 10 years, provided the conditions laid down in the technical literature of the manufacturer relating to packaging, transport, storage, installation, use and repair are met.

The indications given on the intended working life cannot be interpreted as a guarantee given by the producer or the Technical Assessment Body, but are to be regarded only as a means for selecting the appropriate product in relation to the expected economically reasonable working life of the works.

The real working life might be, in normal use conditions, considerably longer without major degradation affecting the Basic requirements for construction works.

2.4 General assumptions

2.4.1 It is assumed that

- > damages to the penetration seal are repaired accordingly,
- > the installation of the penetration seal does not effect the stability of the adjacent building element – even in case of fire,
- > the lintel or floor above the penetration seal is designed structurally and in terms of fire protection such that no additional mechanical load (other than its own weight) is imposed on the penetration seal,
- > the thermal movement in the pipe work will be accommodated in such way that it does not impose a load on the penetration seal,
- > the installations are fixed to the adjacent building element (not to the penetration seal) in accordance with the relevant regulations in such a way that, in case of fire, no additional mechanical load is imposed to the penetration seal,
- > the support of the installations is maintained for the required period of fire resistance and

³ These uses apply for internal humidity class 5 in accordance with EN ISO 13788

- > pneumatic dispatch systems, compressed air systems, etc. are switched off by additional means in case of fire (for sealing off plastic pipes).

2.4.2 This European Technical Assessment does not address any risks associated with the emission of dangerous liquids or gases caused by failure of the pipe(s) in case of fire nor does it prove the prevention of the transmission of fire through heat transfer via the medium in the pipes.

2.4.3 This European Technical Assessment does not verify the prevention of destruction of adjacent building elements with fire separating function or of the pipes themselves due to distortion forces caused by extreme temperatures. These risks shall be accounted for by taking appropriate measures when designing or installing the pipe work.

The mounting or hanging of the pipes or the layout of the pipe work shall be implemented in such a way that the pipes and the fire resistant building elements shall remain functional within a period of time which corresponds to the fire resistance period required.

2.4.4 The risk of downward spread of fire caused by burning material which drips through a pipe to floors below, is not considered in this European Technical Assessment (see EN 1366-3:2009, clause 1).

2.4.5 The durability assessment does not take account of the possible effect on the penetration seal of substances permeating through the pipe walls.

2.4.6 The assessment does not cover the avoidance of destruction of the penetration seal or of the adjacent building element(s) by forces caused by temperature changes in case of fire. This has to be considered when designing the piping system.

2.5 **Manufacturing**

The European Technical Assessment is issued for the product on the basis of agreed data / information, deposited with the Österreichisches Institut für Bautechnik, which identifies the product that has been assessed and judged. Changes to the product or production process, which could result in this deposited data / information being incorrect, should be notified to the Österreichisches Institut für Bautechnik before the changes are introduced.

The Österreichisches Institut für Bautechnik will decide whether or not such changes affect the European Technical Assessment and consequently the validity of the CE marking on the basis of the European Technical Assessment and if so whether further assessment or alterations to the European Technical Assessment, shall be necessary.

3 Performance of the product and references to the methods used for its assessment

Basic requirements for construction works	Essential characteristic	Method of verification	Performance
BWR 2	Reaction to fire	EN 13501-1:2007+A1:2009	Clause 3.1.1 of the ETA
	Resistance to fire	EN 13501-2:2007+A1:2009	Clause 3.1.2 of the ETA and Annex F-1 and Annex J-1 of the ETA
BWR 3	Air permeability (material property)	EN 1026:2016	Clause 3.2.1 of the ETA
	Water permeability (material property)	No performance assessed	
	Content and/or release of dangerous substances	European Council Directive 67/548/EEC and Regulation (EC) No 1272/2008 as well as EOTA TR 034, edition October 2015	Declaration of conformity by the manufacturer
BWR 4	Mechanical resistance and stability	No performance assessed	
	Resistance to impact / movement	No performance assessed	
	Adhesion	No performance assessed	
BWR 5	Airborne sound insulation	EN ISO 10140-2:2010	Clause 3.4.1 of the ETA
BWR 6	Thermal properties	EN 12667:2001	Clause 3.5.1 of the ETA
	Water vapour permeability	No performance assessed	

3.1 Safety in case of fire (BWR 2)

3.1.1 Reaction to fire

The components of "FBS-EN Foam Barrier System" were assessed according to ETAG 026-Part 2 clause 2.4.1 and classified according to EN 13501-1:2007+A1:2009.

Component	Class according to EN 13501-1:2007+A1:2009
FBS-EN Foam Barrier	E
FIB fischer Insulating Bandage	E
FBB-EN Firestop Block	E

3.1.2 Resistance to fire

“FBS-EN Foam Barrier System” was tested according to ETAG 026-Part 2 clause 2.4.2, prEN 1366-3.2:N185:2007-07 and EN 1366-3:2009 in conjunction with EN 1363-1:1999.

Based upon the gained test results and the field of application specified within prEN 1366-3.2:N185:2007-07 and EN 1366-3:2009 “FBS-EN Foam Barrier System” has been classified according to EN 13501-2:2007+A1:2009. The individual fire resistance classes are listed in Annex F-1 (mixed penetration seal) and Annex J-1 (cable penetration seal) of the ETA.

The maximum fire resistance class of the penetration seal in vertical or horizontal separating element depends on the fire resistance class of the penetrating elements. The fire resistance class of the penetration seal is reduced to the fire resistance class of the penetrating element with the lowest fire resistance classification.

The resistance to fire classification listed in Annex F-1 (mixed penetration seal) and Annex J-1 (cable penetration seal) of the ETA is only valid if “FBS-EN Foam Barrier System” is installed according to Annex A-1 to A-6 of the ETA.

3.2 Hygiene, health and environment (BWR 3)

3.2.1 Air permeability

The air permeability of “FBS-EN Foam Barrier” with a thickness of 144 mm was tested according to EN 1026:2016 in a flexible wall with a thickness of 100 mm. The aperture was lined with 1 layer of ≥ 20 mm thick calcium silicate boards (classification A1 according to EN 13501-1) with a width of 144 mm. The opening size was 360 mm x 360 mm (width x height), resp. 0,130 m².

“FBS-EN Foam Barrier System” was tested as blank penetration seal according to ETAG 026-Part 2 clause 2.4.3.

The components “FIB fischer Insulating Bandage” and “FBB-EN Firestop Block” were not included in these tests. The measurement accuracy was 0,01 m³/h.

The values given in the following table are the mean values from the pressure- and suction tests.

Δp in Pa	50	100	150	200	250	300	450	600
q/A in m ³ /(h*m ²)	0,39	0,73	1,18	1,58	1,89	2,12	3,24	4,09

The air permeability of “FBS-EN Foam Barrier” with a thickness of 200 mm was tested according to EN 1026:2016 in a flexible wall with a thickness of 100 mm. The aperture was lined with 1 layer of ≥ 20 mm thick type calcium silicate boards (classification A1 according to EN 13501-1) with a width of 200 mm. The opening size was 350 mm x 350 mm (width x height), resp. 0,123 m².

“FBS-EN Foam Barrier System” was tested as blank penetration seal according to ETAG 026-Part 2 clause 2.4.3.

The components “FIB fischer Insulating Bandage” and “FBB-EN Firestop Block” were not included in these tests.

Up to a pressure difference of 600 Pa no air permeability was measured. The measurement accuracy of the test facility was 0,01 m³/h, so that the air permeability at $\Delta p = 600$ Pa is less than 0,08 m³/(h*m²).

The air permeability of “FBB-EN Firestop Block” with a thickness of 144 mm was tested according to EN 1026:2016 in a flexible wall with a thickness of 100 mm. The aperture was lined with 1 layer of ≥ 20 mm thick calcium silicate boards (classification A1 according to EN 13501-1) with a width of 144 mm. The opening size was 560 mm x 360 mm (width x height), resp. 0,202 m².

“FBS-EN Foam Barrier System” was tested as blank penetration seal according to ETAG 026-Part 2 clause 2.4.3.

The components “FIB fischer Insulating Bandage” and “FBS-EN Foam Barrier” were not included in these tests. The measurement accuracy was 0,01 m³/h.

The values given in the following table are the mean values from the pressure- and suction tests.

Δp in Pa	50	100	150	200	250	300	450	600
q/A in m ³ /(h*m ²)	1,12	1,79	2,38	2,92	3,79	4,42	5,98	7,65

The air permeability of “FBB-EN Firestop Block” with a thickness of 200 mm was tested according to EN 1026:2016 in a flexible wall with a thickness of 100 mm. The aperture was lined with 1 layer of ≥ 20 mm thick calcium silicate boards (classification A1 according to EN 13501-1) with a width of 200 mm. The opening size was 355 mm x 550 mm (width x height), resp. 0,195 m².

“FBS-EN Foam Barrier System” was tested as blank penetration seal according to ETAG 026-Part 2 clause 2.4.3.

The components “FIB fischer Insulating Bandage” and “FBS-EN Foam Barrier” were not included in these tests. The measurement accuracy was 0,01 m³/h.

The values given in the following table are the mean values from the pressure- and suction tests.

Δp in Pa	50	100	150	200	250	300	450	600
q/A in m ³ /(h*m ²)	0,82	1,43	1,74	2,28	3,07	3,74	4,97	6,61

3.2.2 Water permeability

No performance assessed.

3.2.3 Release of dangerous substances

According to the manufacturer’s declaration the products “FBS-EN Foam Barrier”, “FIB fischer Insulating Bandage” and “FBB-EN Firestop Block” do not contain dangerous substances detailed in Council Directive 67/548/EEC and Regulation (EC) no 1272/2008 as well as EOTA TR 034 (General BWR 3 Checklist for EADs/ETAs – Dangerous substances), edition October 2015 above the acceptable limits.

A written declaration in this respect was submitted by the ETA-holder.

In addition to the specific clauses relating to dangerous substances contained in this European Technical Assessment, there may be other requirements applicable to the products falling within its scope (e.g. transposed European legislation and national laws, regulations and administrative provisions). In order to meet the provisions of the Construction Products Regulation, these requirements need also to be complied with, when and where they apply.

3.3 Safety in use (BWR 4)

3.3.1 Mechanical resistance and stability

No performance assessed.

3.3.2 Resistance to impact / movement

No performance assessed.

Provisions shall be taken to prevent a person from stepping onto a horizontal penetration seal or falling against a vertical penetration seal (e.g. by covering with a wire mesh).

3.3.3 Adhesion

No performance assessed.

3.4 Protection against noise (BWR 5)

3.4.1 Airborne sound insulation

The airborne sound insulation of “FBS-EN Foam Barrier” was tested according to EN ISO 10140-2:2010 in a flexible wall with a thickness of 200 mm. The aperture was lined with 1 layers of ≥ 20 mm thick calcium silicate boards (classification A1 according to EN 13501-1) with a width of 200 mm. The opening size was 360 mm x 360 mm (width x height), resp. 0,130 m².

“FBS-EN Foam Barrier System” was tested as blank penetration seal according to ETAG 026-Part 2 clause 2.4.9. The components “FIB fischer Insulating Bandage” and “FBB-EN Firestop Block” were not included in these tests.

The reached values for the airborne sound insulation in accordance with EN ISO 717-1:2013 are given in the following table.

D _{n,e,w} in dB	C in dB	C _{tr} in dB	R _w in dB	C in dB	C _{tr} in dB
66	-1	-6	47	-1	-6

The airborne sound insulation of “FBB-EN Firestop Block” was tested according to EN ISO 10140-2:2010 in a flexible wall with a thickness of 200 mm. The aperture was lined with 1 layers of ≥ 20 mm thick type calcium silicate boards (classification A1 according to EN 13501-1) with a width of 200 mm. The opening size was 360 mm x 360 mm (width x height), resp. 0,130 m².

“FBS-EN Foam Barrier System” was tested as blank penetration seal according to ETAG 026-Part 2 clause 2.4.9. The components “FIB fischer Insulating Bandage” and “FBS-EN Foam Barrier” were not included in these tests.

The reached values for the airborne sound insulation in accordance with EN ISO 717-1:2013 are given in the following table.

D_{n,e,w} in dB	C in dB	C_{tr} in dB	R_w in dB	C in dB	C_{tr} in dB
68	-4	-11	49	-4	-11

3.5 Energy economy and heat retention (BWR 6)

3.5.1 Thermal properties

The thermal properties of “FBS-EN Foam Barrier” and “FBB-EN Firestop Block” were tested according to EN 12667:2001.

Component	λ_{10,23/50} in W/(m*K)
FBS-EN Foam Barrier	0,088
FBB-EN Firestop Block	0,103

3.5.2 Water vapour permeability

No performance assessed.

3.6 General aspects relating to fitness for use

All components of “FBS-EN Foam Barrier System” fulfil the requirements for the intended use category.

“FBS-EN Foam Barrier System” is therefore appropriate for internal use with humidity equal to or higher than 85 % RH, excluding temperatures below 0 °C⁴, without exposure to rain or UV, and can – according to ETAG 026-Part 2 clause 2.4.12.1.3.3 – be categorized as Type Z₁. Since the requirements for Type Z₁ are met, also the requirements for Type Z₂ are fulfilled.

⁴ These uses apply for internal humidity class 5 in accordance with EN ISO 13788

4 Assessment and verification of constancy of performance (hereinafter AVCP) system applied, with reference to its legal base

4.1 AVCP system

According to the Decision 1999/454/EC⁵, amended by Decision 2001/596/EC⁶ of the European Commission the system of assessment and verification of constancy of performance (see Annex V of Regulation (EU) No 305/2011) is given in the following table.

Product(s)	Intended use(s)	Level(s) or class(es) (resistance to fire)	System of assessment and verification of constancy of performance
Fire Stopping and Fire Sealing Products	for fire compartmentation and/or fire protection or fire performance	any	1

In addition, according to the Decision 1999/454/EC, amended by Decision 2001/596/EC of the European Commission the system(s) of assessment and verification of constancy of performance, with regard to reaction to fire, is given in the following table.

Product(s)	Intended use(s)	Level(s) or class(es) (reaction to fire)	System of assessment and verification of constancy of performance
Fire Stopping and Fire Sealing Products	for uses subject to regulations on reaction to fire	A1*, A2*, B*, C*	1
		A1**, A2**, B**, C**, D, E	3
		(A1 to E)***, F	4
<p>* Products/materials for which a clearly identifiable stage in the production process results in an improvement of the reaction to fire classification (e.g. an addition of fire retardants or a limiting of organic material)</p> <p>** Products/materials not covered by footnote (*)</p> <p>*** Products/materials that do not require to be tested for reaction to fire (e.g. products/materials of class A1 according to Commission Decision 96/603/EC, as amended)</p>			

5 Technical details necessary for the implementation of the AVCP system, as provided for in the applicable EAD

Technical details necessary for the implementation of the AVCP system are laid down in the control plan deposited with the Technical Assessment Body Österreichisches Institut für Bautechnik.

The notified product certification body shall visit the factory at least once a year for surveillance of the manufacturer.

Issued in Vienna on 20.11.2017
by Österreichisches Institut für Bautechnik

The original document is signed by:

Rainer Mikulits
Managing Director

⁵ Official Journal of the European Communities no. L 178, 14.7.1999, p. 52

⁶ Official Journal of the European Communities no. L 209, 2.8.2001, p. 33

1 General

- > “FBS-EN Foam Barrier System” can be used in apertures in walls (vertical separating element) and floors (horizontal separating element) according to clause 2.1 of the ETA.
- > The penetration of cables, conduits / tubes, metal pipes, plastic pipes and cable support constructions according to clause 2.1 of the ETA is allowed.
- > The total cross section of the installations (including insulation and cable support constructions) must not be more than 60 % of the opening size of the penetration seal.
- > Metal pipes with an outer diameter > 28 mm have to be insulated with prefabricated pipe shells (e.g. „Rockwool 800”) according to clause 1 of the ETA or „AF/Armaflex”.
- > Metal pipes with an outer diameter ≤ 28 mm can be insulated with prefabricated pipe shells (e.g. „Rockwool 800”) according to clause 1 of the ETA or „AF/Armaflex”.
- > Metal pipes insulated with prefabricated pipe shells (e.g. „Rockwool 800”) according to clause 1 of the ETA can be clad with sheet steel with a thickness of 0,4 mm to 1,0 mm or plastic with a thickness of 0,35 mm to 1,0 mm.

1.1 Pipe end configuration

- > For plastic pipes classified with pipe end configuration U/C the pipe end configuration can be U/C and C/C.
- > For plastic pipes classified with pipe end configuration U/U the pipe end configuration can be U/U, C/U, U/C, C/C.
- > For metal pipes classified with pipe end configuration C/U the pipe end configuration can be C/U and C/C.
- > Plastic conduits were tested U/C resp. U/U.
- > Steel conduits / tubes were tested U/C resp. U/U.

1.2 Orientation of the penetrating elements

- > Conduits / tubes, metal pipes and plastic pipes have to be installed perpendicular to the surface of the penetration seal.
- > Metal pipes insulated with prefabricated pipe shells (e.g. „Rockwool 800”) according to clause 1 of the ETA can be installed in all angles between 90° and 45°.

1.3 Service support constructions

- > All types of cables, conduits / tubes, metal pipes and plastic pipes – in flexible walls and rigid walls – have to be supported on both side of the separating element by steel cable trays (perforated or non-perforated), steel ladders or alternative service support constructions (e.g. pipe hangers) made of metal with a melting or decomposition point greater or equal than 902 °C for EI 45, or 945 °C for EI 60, or 1006 °C for EI 90, or 1049 °C for EI 120 (e.g. stainless steel or galvanized steel) according to the ETA-holder’s installation instructions.

FBS-EN Foam Barrier System
- Details for installation -

ANNEX A-1

- > All types of cables, conduits / tubes, metal pipes and plastic pipes – in rigid floors – have to be supported at least on the top side of the separating element by steel cable trays (perforated or non-perforated), steel ladders or alternative service support constructions (e.g. pipe hangers) made of metal with a melting or decomposition point greater or equal than 842 °C for EI 30, or 945 °C for EI 60, or 1006 °C for EI 90, or 1049 °C for EI 120 (e.g. stainless steel or galvanized steel) according to the ETA-holder's installation instructions.
- > Steel cable trays (perforated or non-perforated) or steel ladders can pass through or end at the surface of the penetration seal.
- > Lidded cable trays / trunkings must not pass through the penetration seal.
- > The first support (service support construction) for cables and conduits / tubes in flexible walls, rigid walls and rigid floors has to be at maximum 200 mm (measured from the surface of the penetration seal).
- > The first support (service support construction) for plastic pipes and metal pipes in flexible walls and rigid walls has to be at maximum 750 mm (measured from the surface of the penetration seal).
- > The first support (service support construction) for plastic pipes and metal pipes in rigid floors has to be at maximum 1200 mm (measured from the surface of the penetration seal).
- > All types of cables, conduits / tubes, metal pipes and plastic pipes have to be fixed according to the ETA-holder's installation instructions to the service support construction.

2 Details for installation of "FBS-EN Foam Barrier System" (see Annex B-1 to J-1 of the ETA)

- > "FBS-EN Foam Barrier System" has to be installed according to the ETA-holder's installation instructions.
- > „FBS-EN Foam Barrier System" will be formed by filling „FBS-EN Foam Barrier" in the opening of the separating element so that all interstices and voids are carefully sealed. Alternatively the remaining space around penetrating elements can be closed with "FBB-EN Firestop Block".
- > It is possible to use formwork for the installation of "FBS-EN Foam Barrier System" in walls and floors. If the formwork consists of cardboard (thickness 3 mm) or adhesive tape, it may remain on the mixed penetration seal / cable penetration seal.
- > For tied cable bundles (see clause 2.1 of the ETA) the space between the cables needs not be filled with "FBS-EN Foam Barrier".

FBS-EN Foam Barrier System
- Details for installation -

ANNEX A-2

2.2 Details for installation in rigid walls (see Annex B-2 to B-3 and G-2 to G-3 of the ETA)

- > For walls thinner than the minimum thickness of the penetration seal (144 mm or 200 mm; mixed penetration seal; depending on the fire resistance classification; see Annex F-1 of the ETA) and 144 mm, 200 mm or 250 mm (cable penetration seal; depending on the fire resistance classification; see Annex J-1 of the ETA) the aperture within the wall shall be lined with minimum 2 layers of $\geq 12,5$ mm thick type F gypsum boards according to EN 520 (classification A2-s1,d0 according to EN 13501-1) or silicate- or calcium silicate boards (classification A1 according to EN 13501-1) with a minimum density of 450 kg/m^3 and a minimum thickness of 25 mm. The boards shall be at least 144 mm or 200 mm (mixed penetration seal; depending on the fire resistance classification; see Annex B-3 and F-1 of the ETA) and 144 mm, 200 mm or 250 mm (cable penetration seal; depending on the fire resistance classification; see Annex G-3 and J-1 of the ETA) wide. The boards have to be installed and fixed according to the ETA-holder's installation instructions.
- > Alternatively the thickness of the wall can be increased to at least 144 mm or 200 mm (mixed penetration seal; depending on the fire resistance classification; see Annex F-1 of the ETA) and 144 mm, 200 mm or 250 mm (cable penetration seal; depending on the fire resistance classification; see Annex J-1 of the ETA) by fitting a board frame, minimum 50 mm wide, around the opening (see Annex B-3 and G-3 of the ETA). Minimum 1 layer of $\geq 12,5$ mm thick type F gypsum boards according to EN 520 (classification A2-s1,d0 according to EN 13501-1) or silicate- or calcium silicate boards (classification A1 according to EN 13501-1) with a minimum density of 450 kg/m^3 can be used. The board frame has to be installed and fixed according to the ETA-holder's installation instructions.
- > Joints between the aperture lining and the aperture have to be filled with "FBS-EN Foam Barrier", or gypsum joint filler or mineral mortar (non-combustible material with classification A2-s1,d0 or A1 according to EN 13501-1 which is dimensionally stable) on both sides of the penetration seal according to the ETA-holder's installation instructions.

FBS-EN Foam Barrier System
- Details for installation -

ANNEX A-4

2.3 Details for installation in rigid floors (see Annex C-1 to C-2 and H-1 to H-2 of the ETA)

- > For floors thinner than the minimum thickness of the penetration seal (200 mm; mixed penetration seal) and 200 mm or 250 mm (cable penetration seal; depending on the fire resistance classification; see Annex J-1 of the ETA) the aperture within the floor shall be lined with minimum 2 layers of $\geq 12,5$ mm thick type F gypsum boards according to EN 520 (classification A2-s1,d0 according to EN 13501-1) or silicate- or calcium silicate boards (classification A1 according to EN 13501-1) with a minimum density of 450 kg/m^3 and a minimum thickness of 25 mm. The boards shall be at least 200 mm (mixed penetration seal; see Annex C-2 of the ETA) and 200 mm or 250 mm (cable penetration seal; depending on the fire resistance classification; see Annex H-2 and J-1 of the ETA) wide. The boards have to be installed and fixed according to the ETA-holder's installation instructions.
- > Alternatively the thickness of the floor can be increased to at least 200 mm (mixed penetration seal) and 200 mm or 250 mm (cable penetration seal; depending on the fire resistance classification; see Annex J-1 of the ETA) by fitting a board frame, minimum 50 mm wide, around the opening (see Annex C-2 and H-2 of the ETA). Minimum 1 layer of $\geq 12,5$ mm thick type F gypsum boards according to EN 520 (classification A2-s1,d0 according to EN 13501-1) or silicate- or calcium silicate boards (classification A1 according to EN 13501-1) with a minimum density of 450 kg/m^3 can be used. The board frame has to be installed and fixed according to the ETA-holder's installation instructions.
- > Joints between the aperture lining and the aperture have to be filled with „FBS-EN Foam Barrier“, or gypsum joint filler or mineral mortar (non-combustible material with classification A2-s1,d0 or A1 according to EN 13501-1 which is dimensionally stable) on both sides of the penetration seal according to the ETA-holder's installation instructions.

3 Minimum working clearances

- > The minimum working clearances (a1, a2, a3; for pipes only linear arrangement is allowed, no clusters) and the minimum clearance between the penetration seals are specified in Annex B-1 to D-1 (mixed penetration seal) and G-1 to H-2 (cable penetration seal) of the ETA.

FBS-EN Foam Barrier System
- Details for installation -

ANNEX A-5

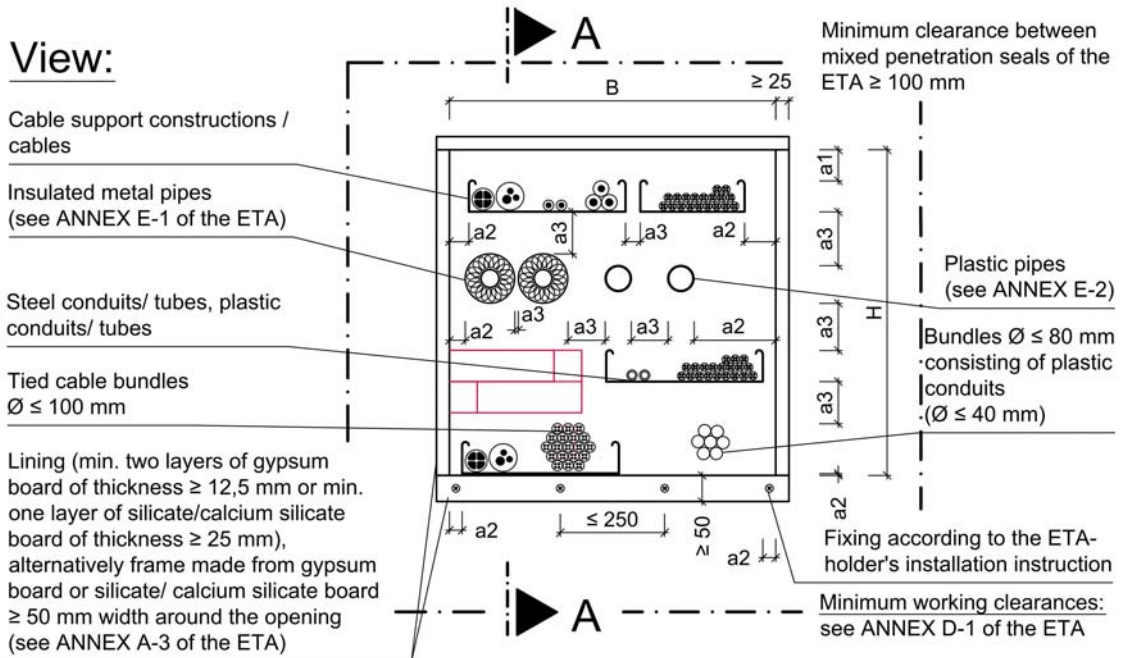

Cross Section A-A:

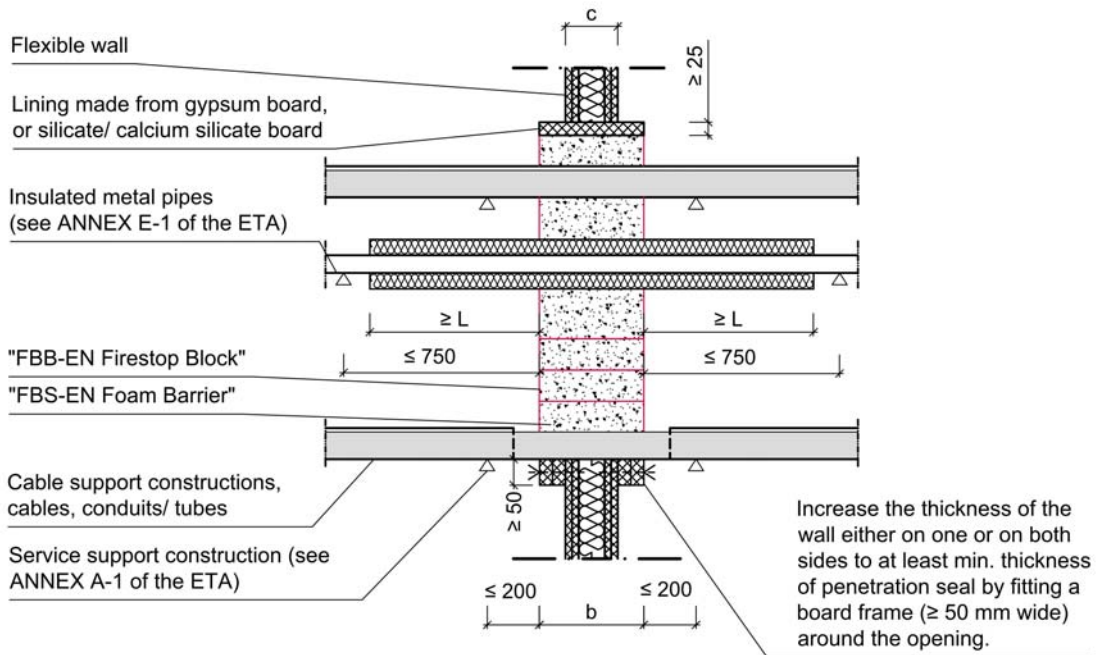

All dimensions in mm

Separating element	Fire resistance classification	Wall thickness c [mm]	Max. opening size		Thickness of penetration seal (b)
			H [mm]	B [mm]	
Flexible wall	see ANNEX F-1 of the ETA	≥ 94	≤ 500	≤ 450	see ANNEX F-1 of the ETA

FBS-EN Foam Barrier System
- mixed penetration seal
- Installation in flexible wall, thickness c ≥ 94 mm -

ANNEX B-1

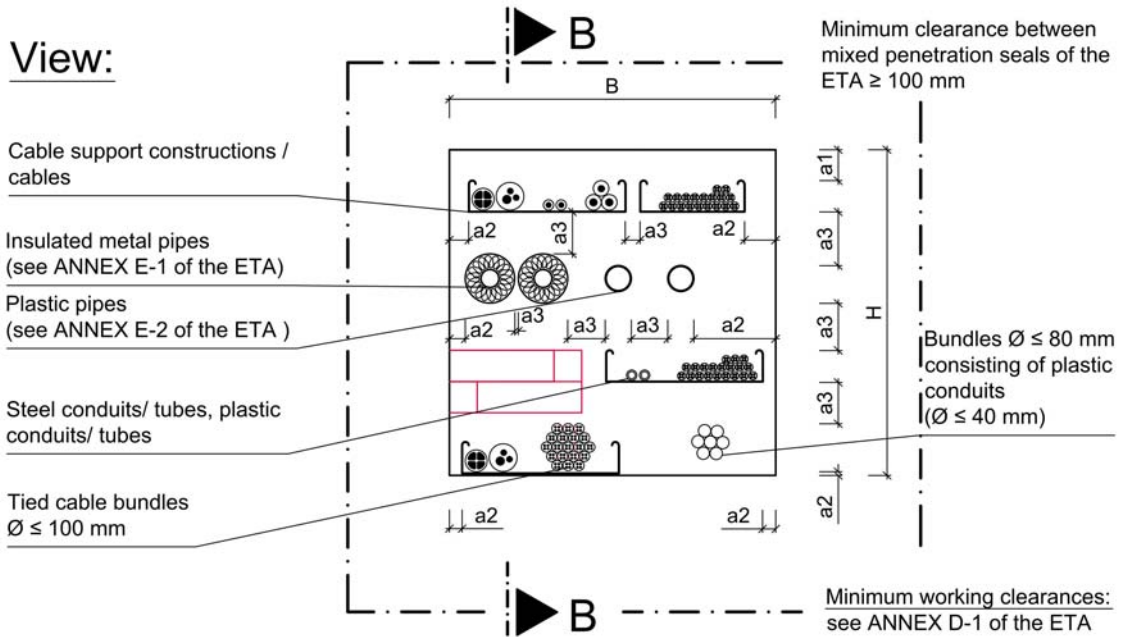

Cross Section B-B:

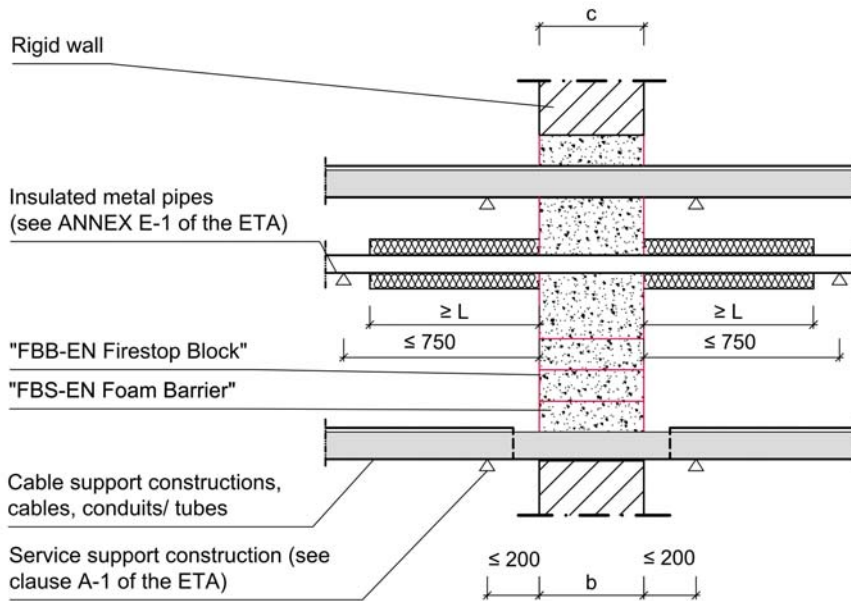

All dimensions in mm

Separating element	Fire resistance classification	Wall thickness c [mm]	Max. opening size		Thickness of penetration seal (b)
			H [mm]	B [mm]	
Rigid wall	see ANNEX F-1 of the ETA	$\geq b$	≤ 500	≤ 450	see ANNEX F-1 of the ETA

FBS-EN Foam Barrier System

- mixed penetration seal

- Installation in rigid wall, thickness $c \geq b$ -

ANNEX B-2

View:

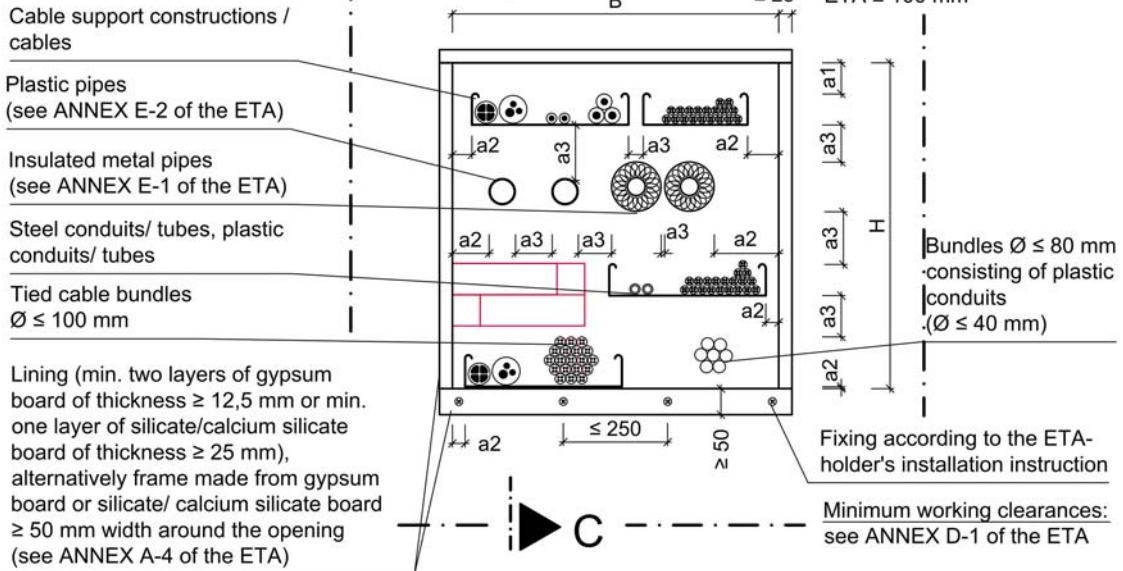

Cross Section C-C:

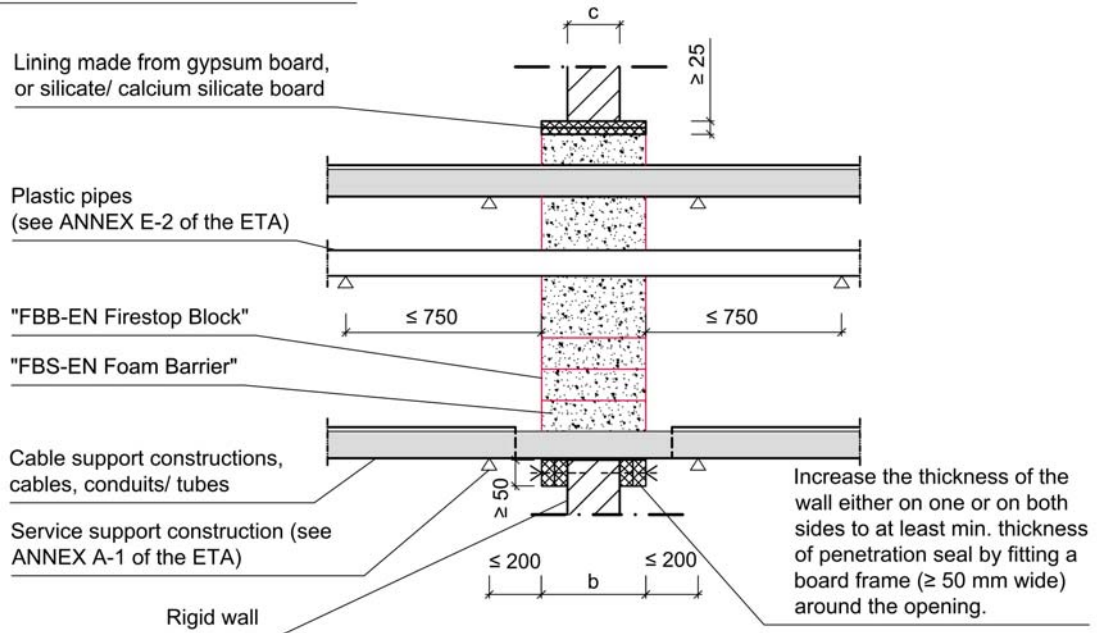

All dimensions in mm

Separating element	Fire resistance classification	Wall thickness c [mm]	Max. opening size		Thickness of penetration seal (b)
			H [mm]	B [mm]	
Rigid wall	see ANNEX F-1 of the ETA	$100 \leq c < b$	≤ 500	≤ 450	see ANNEX F-1 of the ETA

FBS-EN Foam Barrier System

- mixed penetration seal

- Installation in rigid wall, thickness $100 \text{ mm} \leq c < b$ -

ANNEX B-3

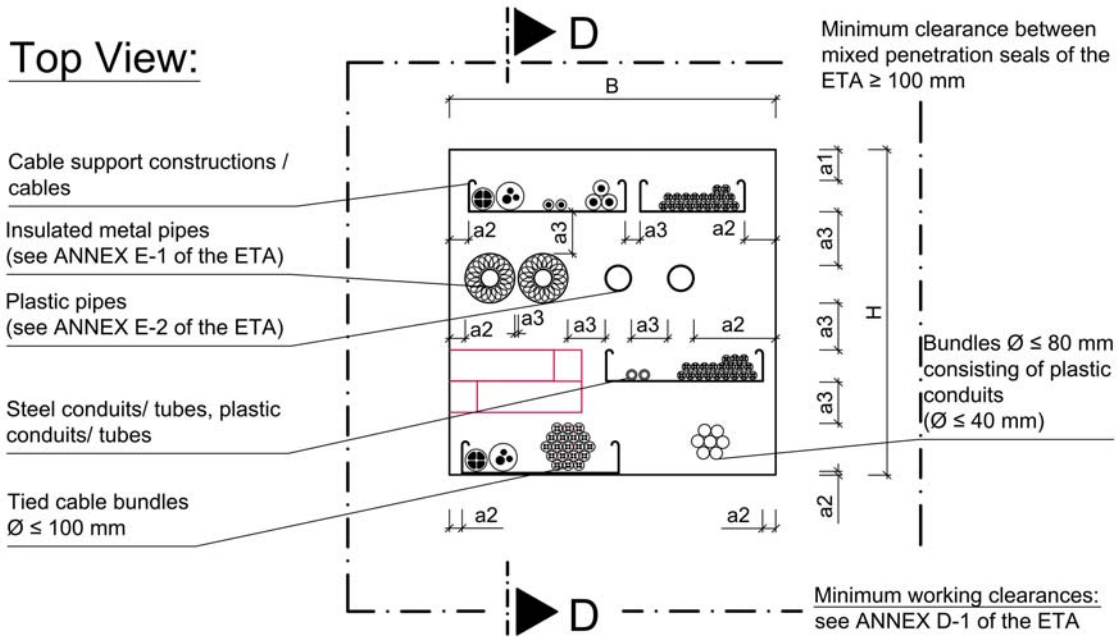

Cross Section D-D:

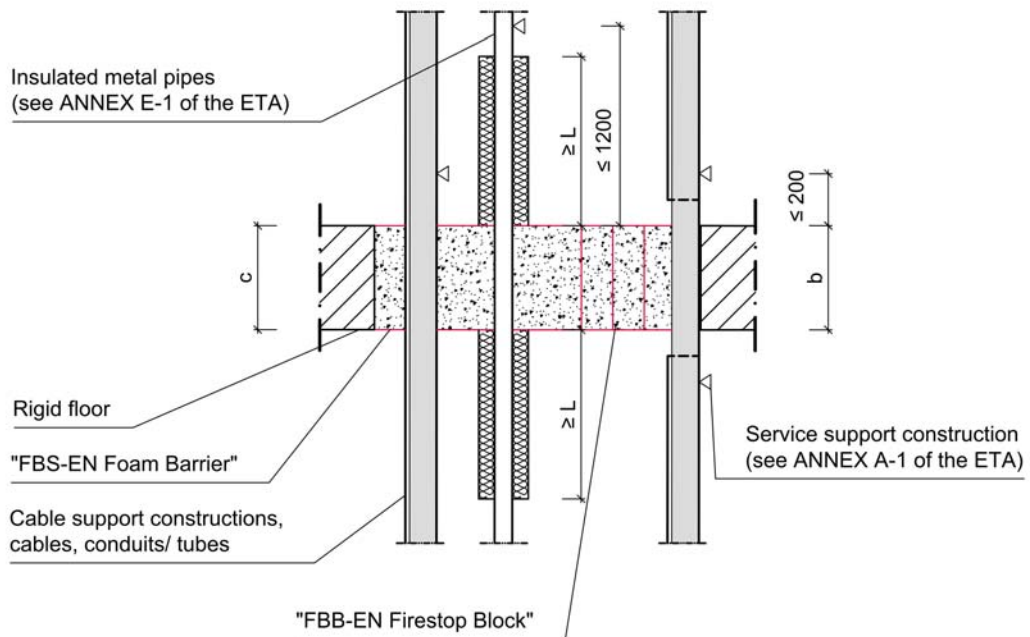

All dimensions in mm

Separating element	Fire resistance classification	Floor thickness c [mm]	Max. opening size		Thickness of penetration seal (b)
			H [mm]	B [mm]	
Rigid Floor	see ANNEX F-1 of the ETA	$\geq b$ (min. 150 mm)	≤ 450	≤ 450	see ANNEX F-1 of the ETA

FBS-EN Foam Barrier System
- mixed penetration seal
- Installation in rigid floor, thickness $c \geq b$ -

ANNEX C-1

Top View:

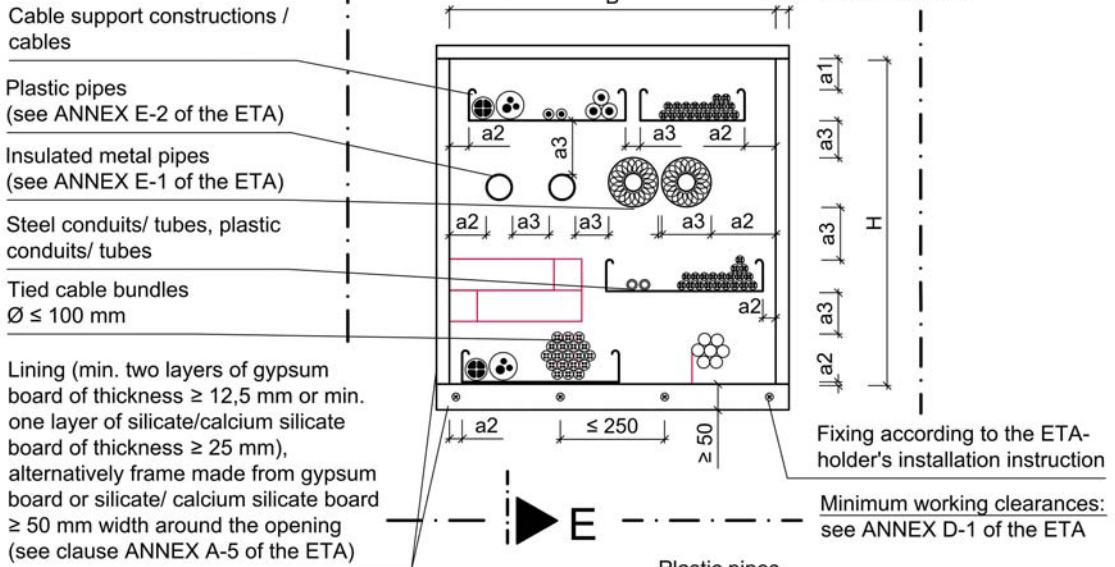

Cross Section E-E:

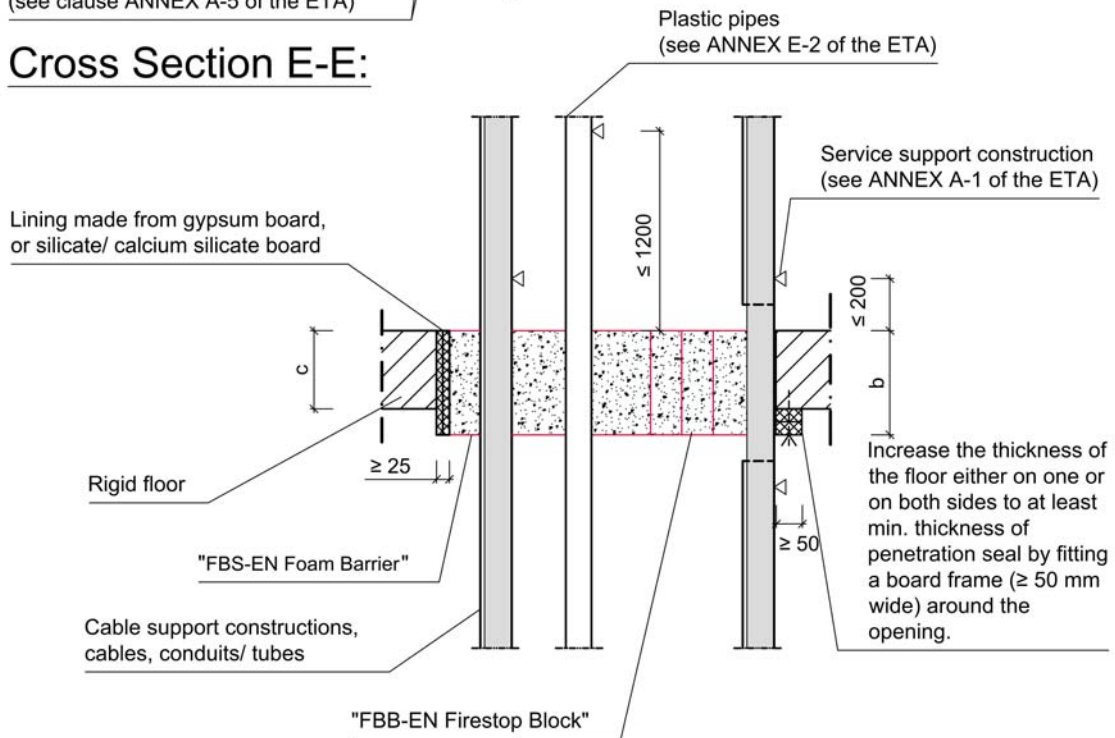

All dimensions in mm

Separating element	Fire resistance classification	Floor thickness c [mm]	Max. opening size		Thickness of penetration seal (b)
			H [mm]	B [mm]	
Rigid Floor	see ANNEX F-1 of the ETA	$150 \leq c < b$	≤ 450	≤ 450	see ANNEX F-1 of the ETA

FBS-EN Foam Barrier System

- mixed penetration seal

- Installation in rigid floor, thickness $150 \text{ mm} \leq c < b$ -

ANNEX C-2

View:

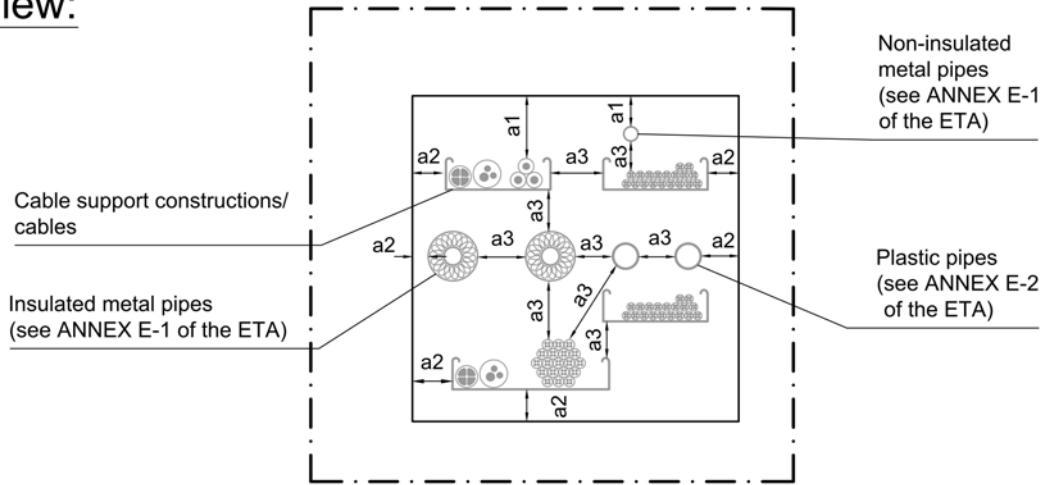

Minimum working clearances:

- a1: Penetrating element / top edge of penetration seal
- a2: Penetrating element / side or lower edge of penetration seal
- a3: Penetrating element / Penetrating element

<u>Minimum working clearance</u>			
Penetrating element	a1	a2	a3
Cables/ Cable trays/ Conduits	50 mm	0 mm	• Cables/ Cable trays/ Conduits, horizontal 0 mm
			• Cables/ Cable trays/ Conduits, vertical 50 mm
			• Non-insulated metal pipes 60 mm
			• Other penetrating elements 50 mm
Mineral wool (see clause 1 of the ETA) insulated metal pipes	0 mm	0 mm	• Mineral wool insulated metal pipes 0 mm
			• Non-insulated metal pipes 60 mm
			• Other penetrating elements 50 mm
AF/Armaflex insulated metal pipes	35 mm	35 mm	• AF/Armaflex (thickness > 9 mm) insulated metal pipes 35 mm
			• AF/Armaflex (thickness 9 mm) insulated metal pipes 50 mm
			• Non-insulated metal pipes 60 mm
			• Other penetrating elements 50 mm
Non-insulated metal pipes	35 mm	35 mm	• Non-insulated metal pipes 60 mm
			• Other penetrating elements 60 mm
Plastic pipes	50 mm	50 mm	• Plastic pipes 50 mm
			• Non-insulated metal pipes 60 mm
			• Other penetrating elements 50 mm

FBS-EN Foam Barrier System
- mixed penetration seal
- Minimum working clearances -

ANNEX D-1

Field of application of metal pipes

Mineral wool (acc. to clause 1 of the ETA) insulated metal pipes acc. to clause 2.1 of the ETA (C/U) and (C/C)

Metal pipes made of copper, steel, stainless steel, cast iron insulated with mineral wool, insulation optional sustained (LS, CS) or interrupted (LI, CI), optional clad with sheet steel (0,4 mm - 1,0 mm) or plastic (0,35 mm - 1,0 mm)

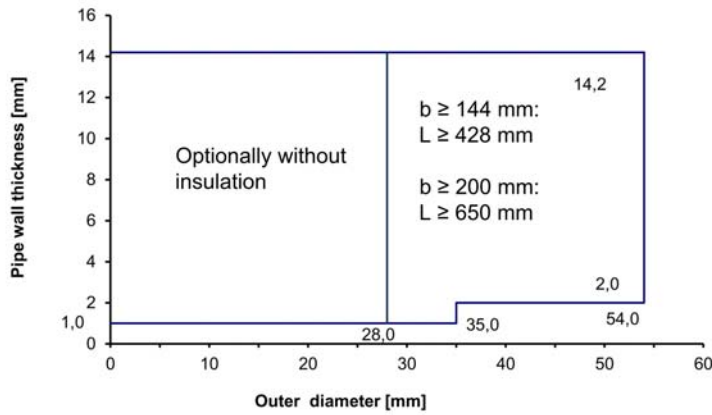

L measured from the surface of the penetration seal (see ANNEX B-1 to C-2 of the ETA).

Case	Density of mineral wool	Thickness of mineral wool
LI (local-interrupted)	$\geq 90 \text{ kg/m}^3$	30 mm
LS (local-sustained)		30 mm
CI (continued-interrupted)		$\geq 30 \text{ mm}$
CS (continued-sustained)		$\geq 30 \text{ mm}$

AF/Armaflex insulated metal pipes (C/U) and (C/C)

Metal pipes made of copper, steel, stainless steel, cast iron insulated with AF/Armaflex, insulation sustained (LS or CS), minimum length 500 mm on both sides of mixed penetration seal

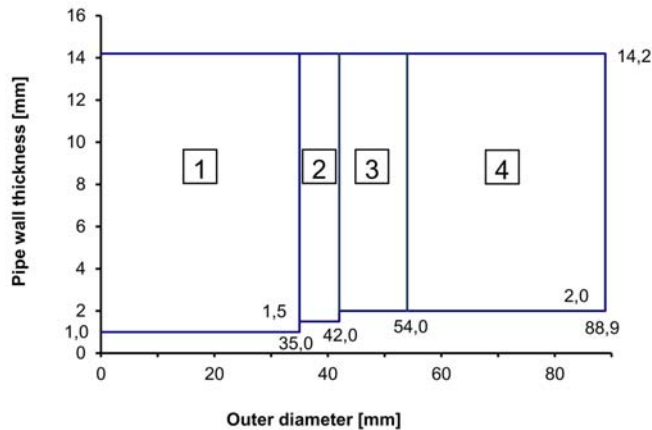

- 1 Insulation thickness 9,0 mm to 35,0 mm, $L \geq 500 \text{ mm}$
- 2 Insulation thickness 9,0 mm to 36,5 mm, $L \geq 500 \text{ mm}$
- 3 Insulation thickness 9,0 mm to 38,0 mm, $L \geq 500 \text{ mm}$
- 4 Insulation thickness 41,5 mm, $L \geq 500 \text{ mm}$

Interpolation between pipe diameters and wall thicknesses for metal pipes according to clause 2.1 of the ETA in flexible walls, rigid walls and rigid floors - mixed penetration seal

ANNEX E-1

Field of application of plastic pipes (U/U), (C/U), (U/C) and (C/C):

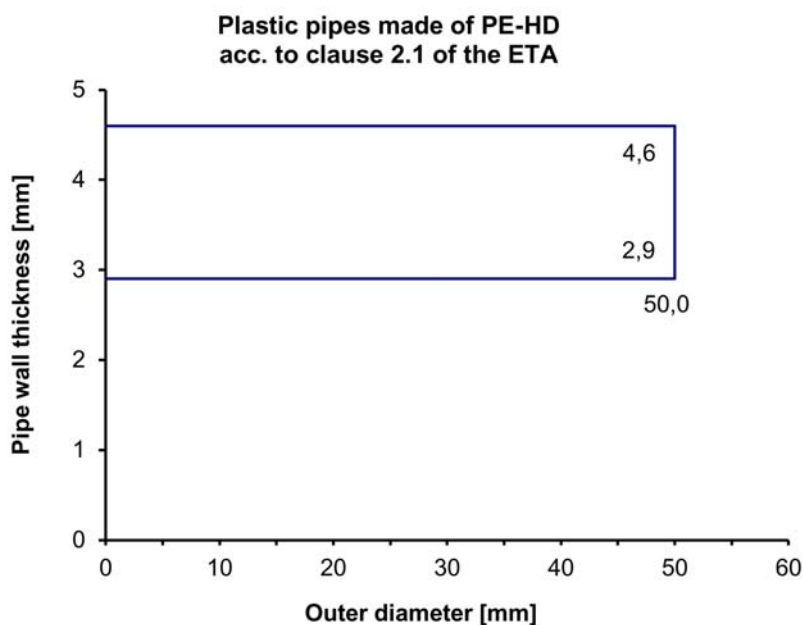
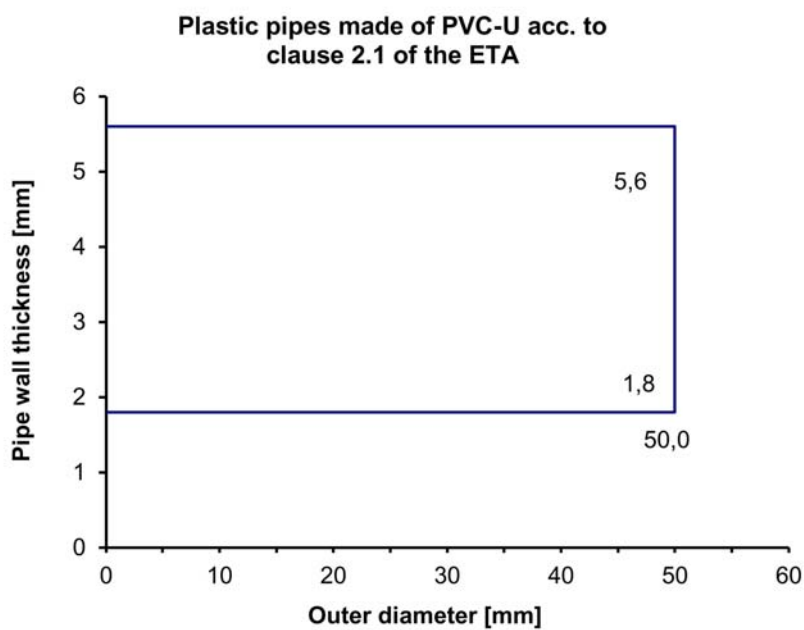

Interpolation between pipe diameters and wall thicknesses for plastic pipes according to clause 2.1 of the ETA in flexible walls, rigid walls and rigid floors - mixed penetration seal

ANNEX E-2

Fire resistance classification of mixed penetration seals:

Installation in flexible walls of at least 94 mm thickness and rigid walls of at least 100 mm thickness (max. opening size of 450 mm x 500 mm)
or rigid floors of at least 150 mm thickness (max. opening size of 450 mm x 450 mm)

Penetrating element	Min. thickness of mixed penetration seal	
	b ≥ 144 mm	b ≥ 200 mm
Sheathed electrical/ telecommunication /optical fibre cables up to a maximum outer diameter of 80 mm	wall: E 120 / EI 60 floor: E 60 / EI 60	wall and floor: E 120 / EI 90
Tied bundles up to 100 mm overall diameter containing sheathed electrical/ telecommunication /optical fibre cables of a max.diameter up to 21 mm	wall: E 120 / EI 60 floor: E 60 / EI 60	wall and floor: E 120 / EI 90
Non-sheathed cables up to a maximum outer diameter of 24 mm	wall: E 120 / EI 45 floor: E 60 / EI 30	wall and floor: E 120 / EI 60
Steel conduits/ tubes up to Ø 16 mm with/ without cables	wall: E 120-U/C / EI 60-U/C floor: E 60-U/C / EI 60-U/C	wall and floor: E 120-U/U / EI 90-U/U
Plastic conduits up to Ø 16 mm with/ without cables	wall: E 120-U/C / EI 90-U/C floor: E 60-U/C / EI 60-U/C	wall and floor: E 120-U/U / EI 120-U/U
Plastic conduits up to Ø 40 mm and bundles up to 80 mm consisting of plastic conduits (Ø ≤ 40 mm) with/ without cables	wall: E 120-U/C / EI 90-U/C floor: E 60-U/C / EI 60-U/C	wall: E 120-U/C / EI 120-U/C floor: E 120-U/U / EI 120-U/U
Non-insulated metal pipes up to a max. outer diameter of 28 mm	wall: E 120-C/U / EI 60-C/U floor: E 60-C/U / EI 60-C/U	wall and floor: E 120-C/U / EI 90-C/U
Mineral wool insulated metal pipes up to a max. outer diameter of 54 mm	wall: E 120-C/U / EI 90-C/U floor: E 60-C/U / EI 60-C/U	wall and floor: E 120-C/U / EI 90-C/U
AF/Armaflex (thickness 9 mm) insulated metal pipes up to a max. outer diameter of 54 mm*	wall: E 120-C/U / EI 90-C/U floor: E 60-C/U / EI 60-C/U	wall and floor: E 120-C/U / EI 90-C/U
AF/Armaflex (thickness > 9 mm) insulated metal pipes up to a max. outer diameter of 88,9 mm*	wall: E 120-C/U / EI 90-C/U floor: E 60-C/U / EI 60-C/U	wall and floor: E 120-C/U / EI 120-C/U
Plastic pipes up to a max. outer diameter of 50 mm	wall: E 120-U/C / EI 120-U/C floor: E 60-U/C / EI 60-U/C	wall and floor: E 120-U/U / EI 120-U/U

* For permitted insulation see ANNEX E-1 of the ETA

FBS-EN Foam Barrier System
- mixed penetration seal
- Fire resistance classification -

ANNEX F-1

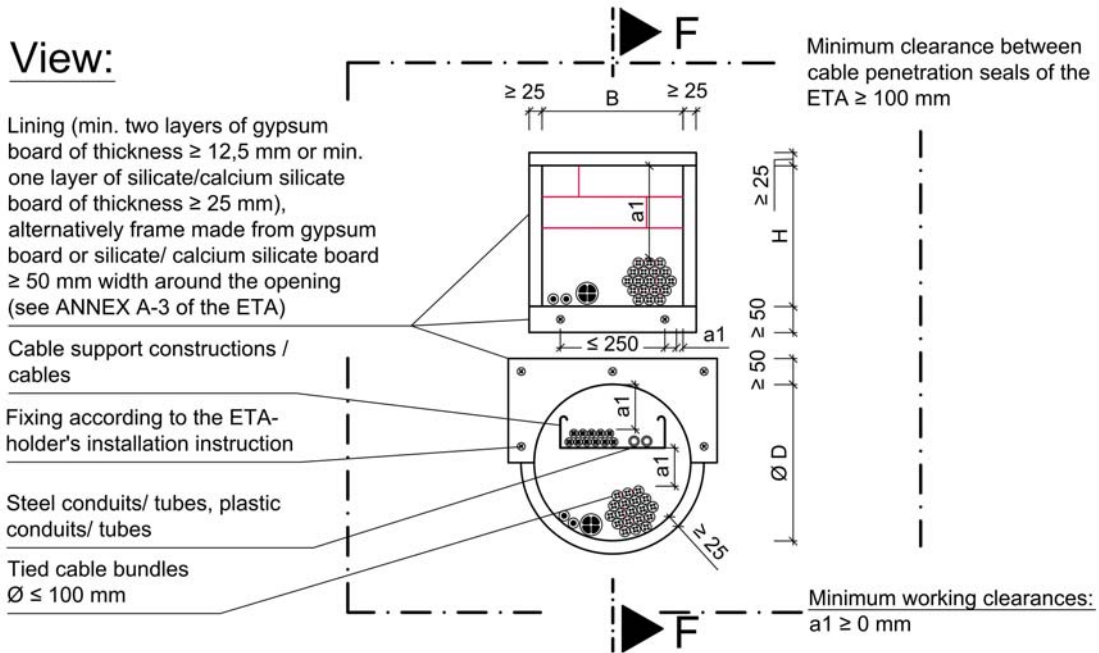

Cross Section F-F:

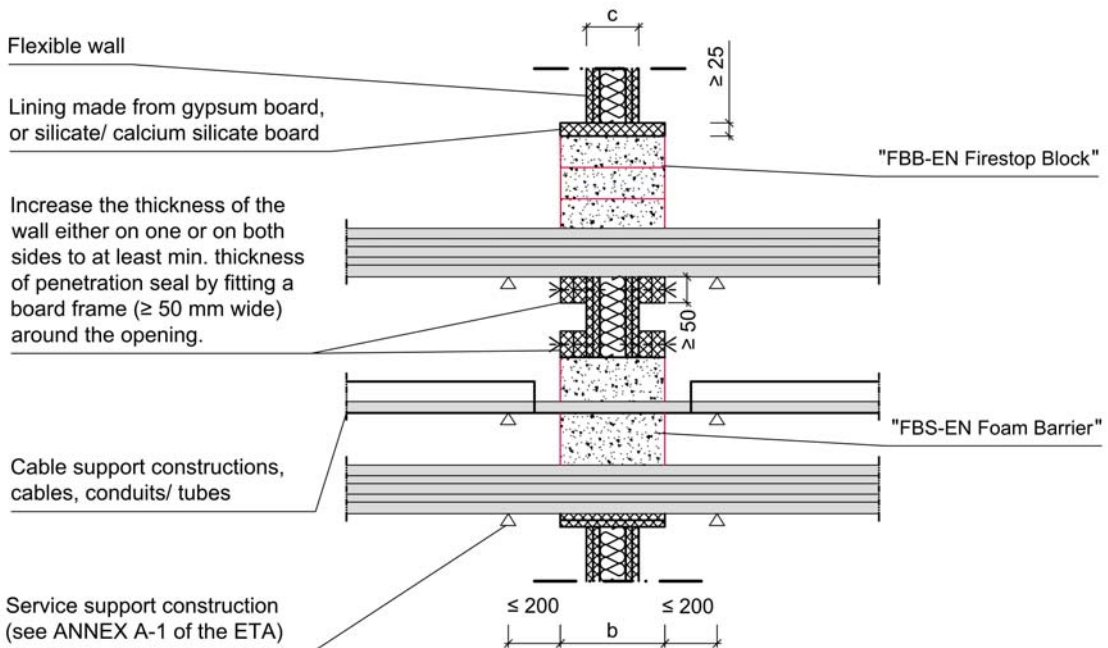

All dimensions in mm

Separating element	Fire resistance classification	Wall thickness c [mm]	Max. opening size H [mm] x B [mm] / \varnothing D [mm]	Thickness of penetration seal (b)
Flexible wall	see ANNEX J-1 of the ETA	≥ 94	$\leq 270 \times 270 / \varnothing \leq 300$	see ANNEX J-1 of the ETA

FBS-EN Foam Barrier System
- cable penetration seal
- Installation in flexible wall, thickness $c \geq 94$ mm -

ANNEX G-1

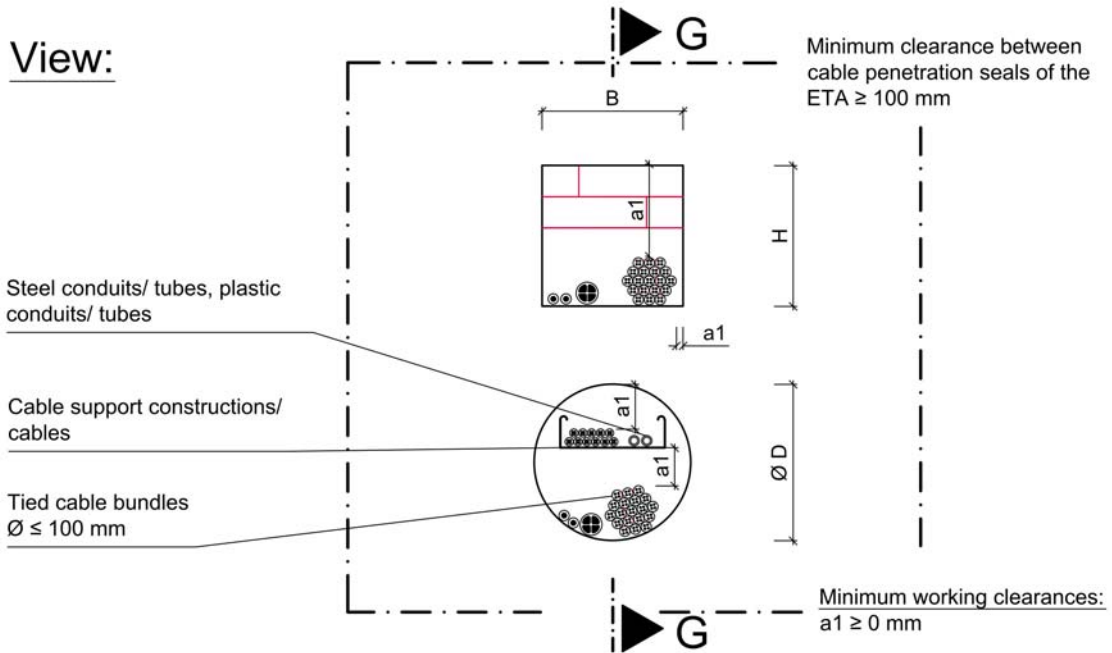

Cross Section G-G:

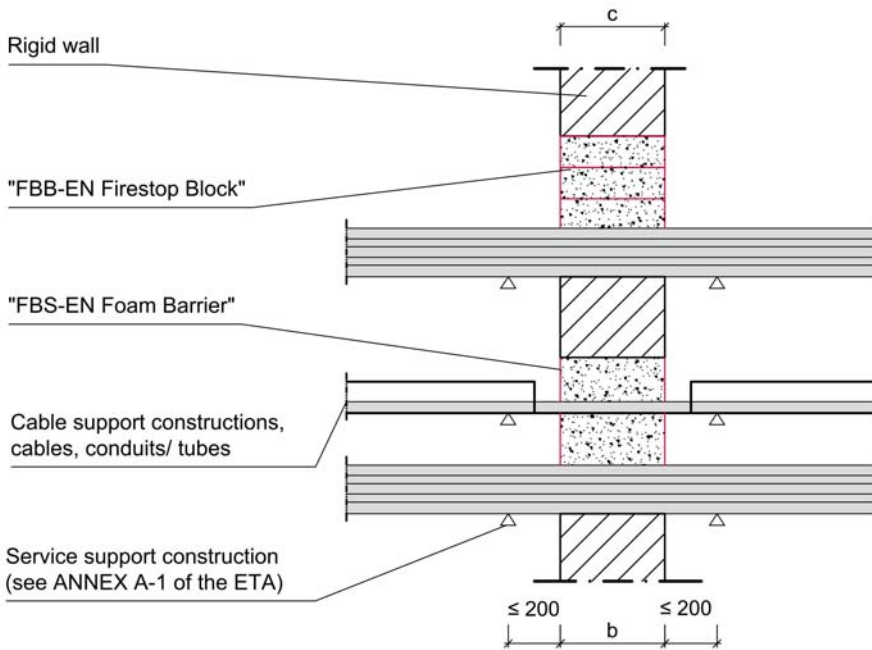

All dimensions in mm

Separating element	Fire resistance classification	Wall thickness c [mm]	Max. opening size H [mm] x B [mm] / \varnothing D [mm]	Thickness of penetration seal (b)
Rigid wall	see ANNEX J-1 of the ETA	$\geq b$	$\leq 270 \times 270 / \varnothing \leq 300$	see ANNEX J-1 of the ETA

FBS-EN Foam Barrier System
- cable penetration seal
- Installation in rigid wall, thickness $c \geq b$ -

ANNEX G-2

View:

Lining (min. two layers of gypsum board of thickness $\geq 12,5$ mm or min. one layer of silicate/calcium silicate board of thickness ≥ 25 mm), alternatively frame made from gypsum board or silicate/ calcium silicate board ≥ 50 mm width around the opening (see ANNEX A-4 of the ETA)

Cable support constructions/ cables

Steel conduits/ tubes, plastic conduits/ tubes

Tied cable bundles $\varnothing \leq 100$ mm

Fixing according to the ETA-holder's installation instruction

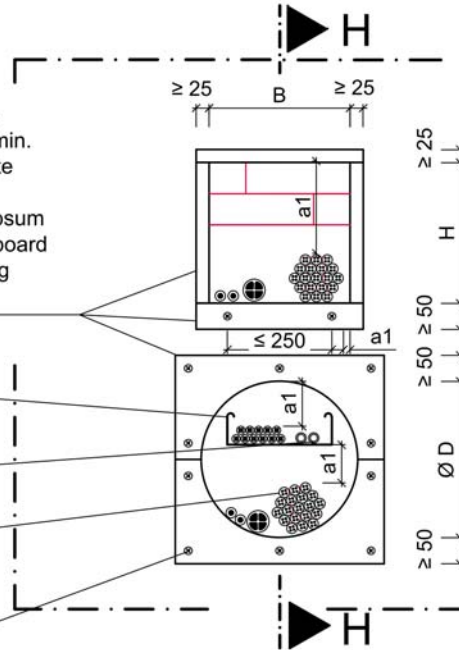

Minimum clearance between cable penetration seals of the ETA ≥ 100 mm

Minimum working clearances: $a1 \geq 0$ mm

Cross Section H-H:

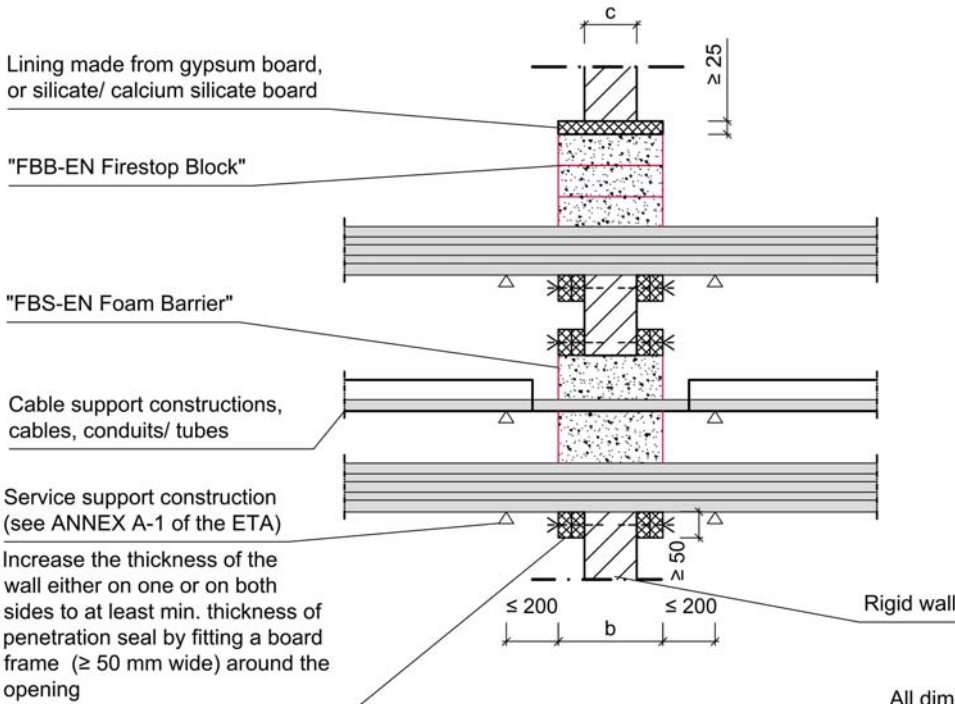

All dimensions in mm

Separating element	Fire resistance classification	Wall thickness c [mm]	Max. opening size H [mm] x B [mm] / Ø D [mm]	Thickness of penetration seal (b)
Rigid wall	see ANNEX J-1 of the ETA	$100 \leq c < b$	$\leq 270 \times 270 / \varnothing \leq 300$	see ANNEX J-1 of the ETA

FBS-EN Foam Barrier System

- cable penetration seal

- Installation in rigid wall, thickness $100 \text{ mm} \leq c < b$ -

ANNEX G-3

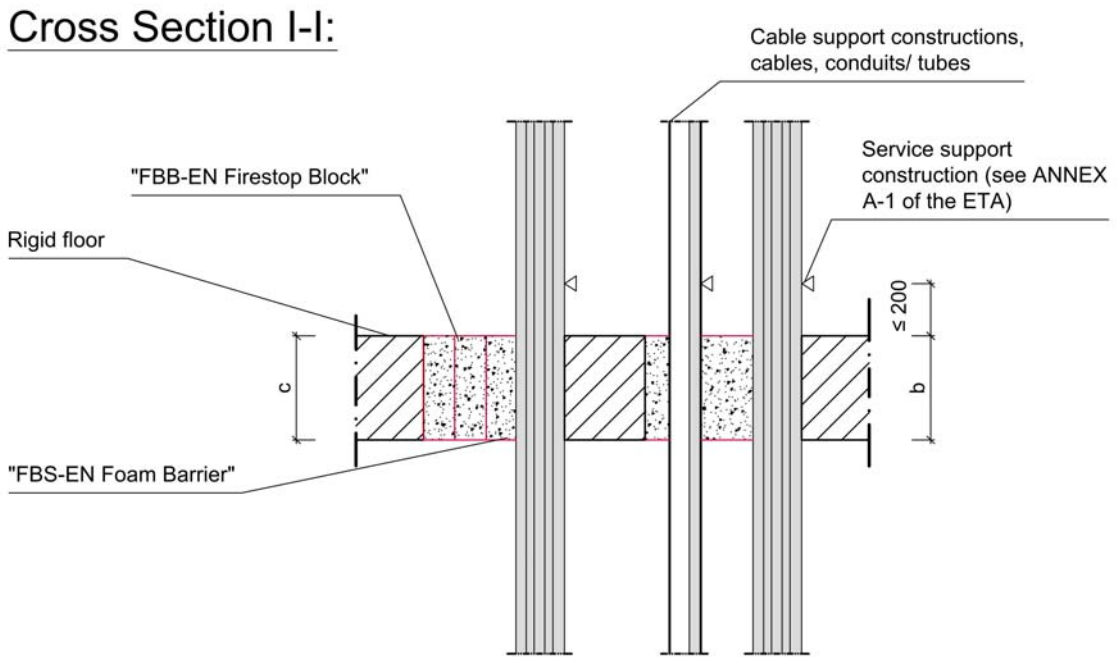
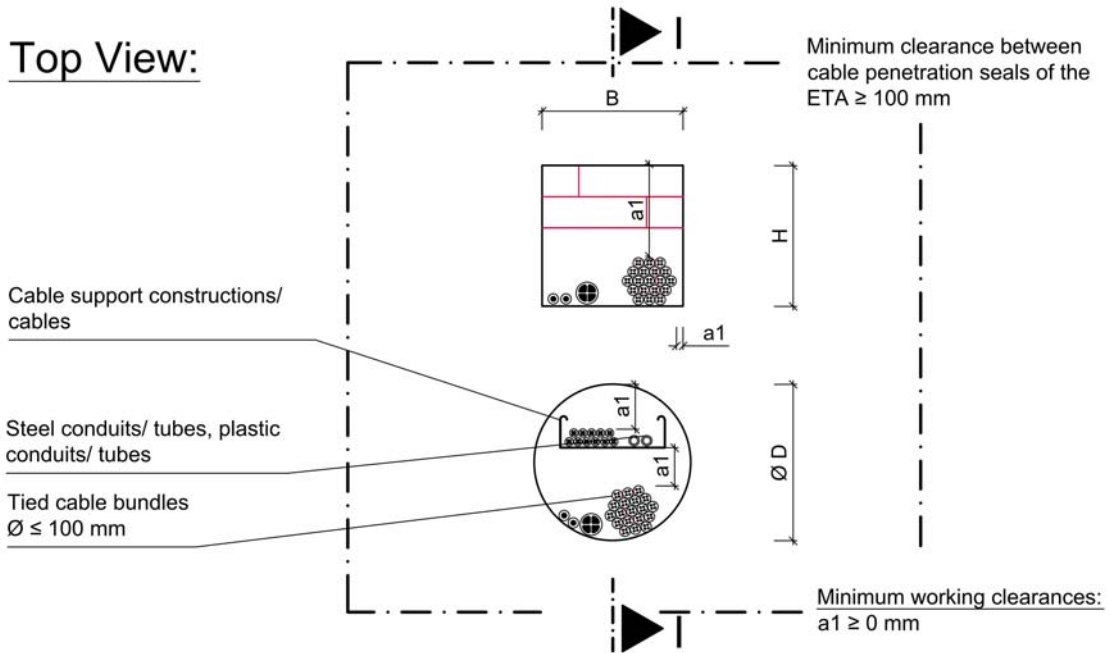

All dimensions in mm

Separating element	Fire resistance classification	Wall thickness c [mm]	Max. opening size H [mm] x B [mm] / Ø D [mm]	Thickness of penetration seal (b)
Rigid floor	see ANNEX J-1 of the ETA	≥ b (min. 150 mm)	≤ 270 x 270 / Ø ≤ 300	see ANNEX J-1 of the ETA

FBS-EN Foam Barrier System
- cable penetration seal
- Installation in rigid floor, thickness $c \geq b$ -

ANNEX H-1

Top View:

Lining (min. two layers of gypsum board of thickness $\geq 12,5$ mm or min. one layer of silicate/calcium silicate board of thickness ≥ 25 mm), alternatively frame made from gypsum board or silicate/ calcium silicate board ≥ 50 mm width around the opening (see ANNEX A-5 of the ETA)

Cable support constructions/ cables

Steel conduits/ tubes, plastic conduits/ tubes

Tied cable bundles $\varnothing \leq 100$ mm

Fixing according to the ETA-holder's installation instruction

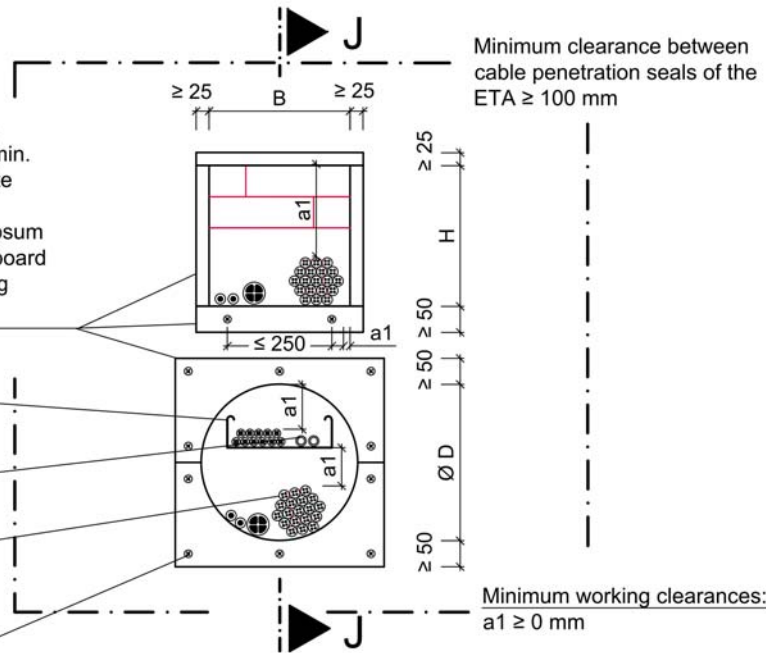

Cross Section J-J:

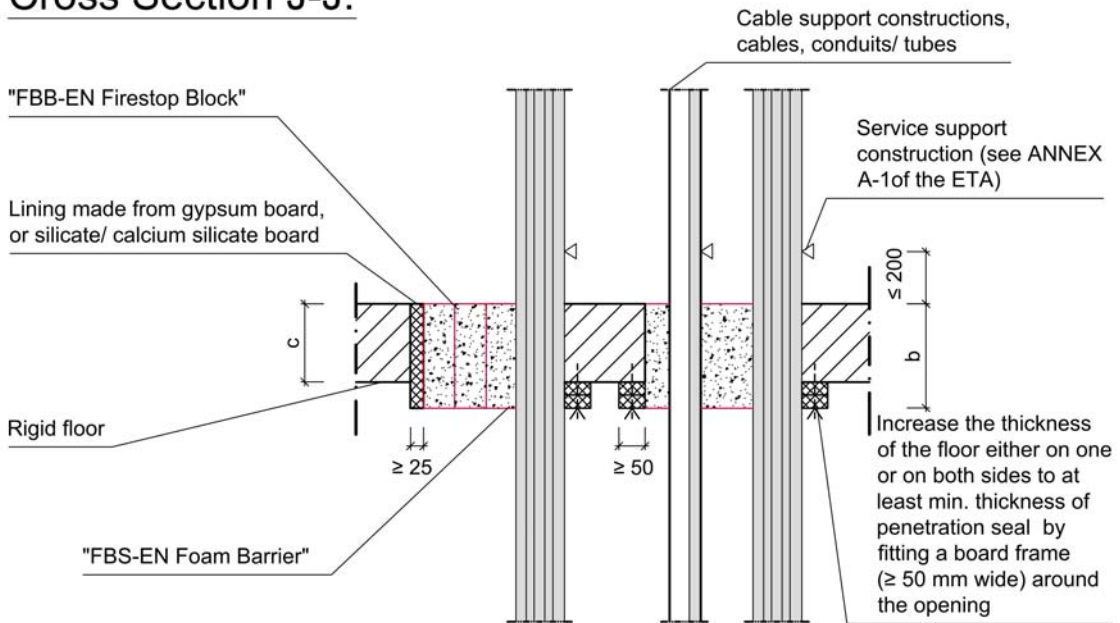

All dimensions in mm

Separating element	Fire resistance classification	Wall thickness c [mm]	Max. opening size H [mm] x B [mm] / Ø D [mm]	Thickness of penetration seal (b)
Rigid floor	see ANNEX J-1 of the ETA	$150 \leq c < b$	$\leq 270 \times 270 / \varnothing \leq 300$	see ANNEX J-1 of the ETA

FBS-EN Foam Barrier System

- cable penetration seal

- Installation in rigid floor, thickness $150 \text{ mm} \leq c < b$ -

ANNEX H-2

Arrangement of "FIB fischer Insulating Bandage"
for fire resistance classification EI 120
(see ANNEX J-1 of the ETA):

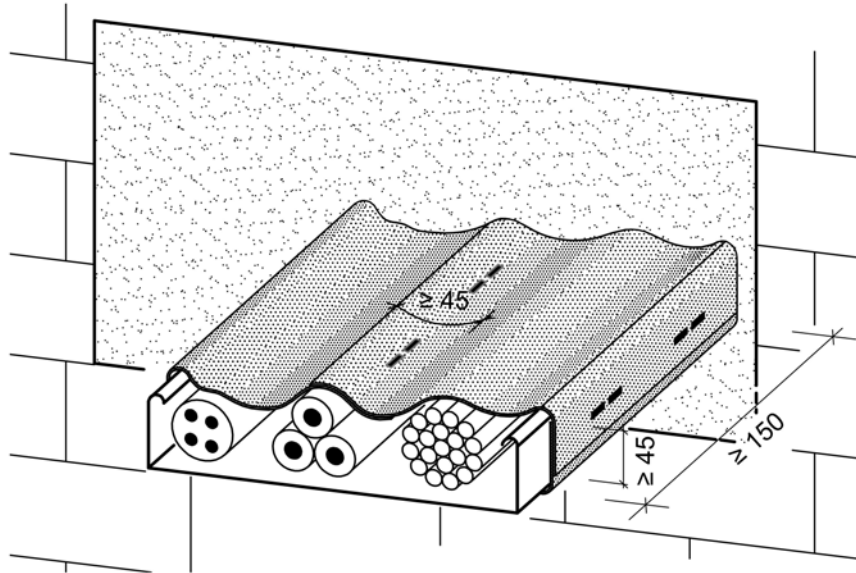

For fire resistance classification EI120:

The cables or cable trays have to be wrapped with strips of "FIB fischer Insulating Bandage" of at least 150 mm width on both sides. The glass fabric reinforcement fixed to one side of the wrap has to be on the outside. The ends of the wrap have to be fixed with two steel clips or steel wire according to the ETA-holder's installation instruction. Strips have to overlap each other at least 45 mm.

All dimensions in mm

FBS-EN Foam Barrier System
- cable penetration seal
- Arrangement of "FIB fischer Insulating Bandage" -

ANNEX I-1

Fire resistance classification of cable penetration seals:
Installation in flexible walls of at least 94 mm thickness and rigid walls of at least 100 mm thickness or rigid floors of at least 150 mm thickness
(max. opening size of 270 mm x 270 mm or Ø 300 mm)

Penetrating element	Min. thickness of cable penetration seal			
	b ≥ 100 mm	b ≥ 144 mm	b ≥ 200 mm	b ≥ 250 mm
Sheathed electrical/telecommunication /optical fibre cables up to a maximum outer diameter of 21 mm	E 120 EI 60	E 120 EI 90	E 120 wall: EI 90 / EI 120 ²⁾ floor: EI 120	E 120 EI 120
Sheathed electrical/telecommunication /optical fibre cables up to a maximum outer diameter of 21 mm < Ø ≤ 50 mm	wall: E 120 / EI 45 / EI 60 ¹⁾	E 120 EI 60	E 120 EI 90 / EI 120 ²⁾	E 120 EI 120
Sheathed electrical/telecommunication /optical fibre cables up to a maximum outer diameter of 50 mm < Ø ≤ 80 mm	---	E 120 EI 60	E 120 EI 90/ EI 120 ²⁾	E 120 EI 90
Tied bundles up to 100 mm overall diameter containing sheathed electrical/ telecommunication /optical fibre cables of a max.diameter up to 21 mm	---	E 120 EI 60	E 120 wall: EI 90 floor: EI 90/ EI 120 ²⁾	E 120 wall: EI 90 floor: EI 120
Non-sheathed cables up to a maximum outer diameter of 24 mm	---	E 120 wall: EI 45 floor: EI 30	E 120 wall: EI 90 floor: EI 60	E 120 wall: EI 90 floor: EI 60
Steel conduits/ tubes up to Ø 16 mm with/ without cables	---	E 120-U/C EI 60-U/C	E 120-U/U wall: EI 120-U/U floor: EI 90-U/U	E 120-U/U wall: EI 120-U/U floor: EI 120-U/U
Plastic conduits up to Ø 16 mm with/ without cables	---	E 120-U/C EI 120-U/C	E 120-U/U EI 120-U/U	E 120-U/U EI 120-U/U
Plastic conduits up to Ø 40 mm and bundles up to 80 mm consisting of plastic conduits (Ø ≤ 40 mm) with/ without cables	---	E 120-U/C EI 120-U/C	wall: E 120-U/C / EI 120-U/C floor: E 120-U/U / EI 120-U/U	wall: E 120-U/C / EI 120-U/C floor: E 120-U/U / EI 120-U/U

- 1) A bead of "FBS-EN Foam Barrier" with min. dimension of 30 mm x 20mm (length x thickness) has to be applied around the penetrating element on both sides of the penetration seal.
- 2) "FIB fischer Insulating Bandage" (see ANNEX I-1) has to be wrapped around the penetrating element on both sides of the penetration seal.

FBS-EN Foam Barrier System
- cable penetration seal
- Fire resistance classification -

ANNEX J-1