





Varistar  **1200 mm**

Data Solutions

???

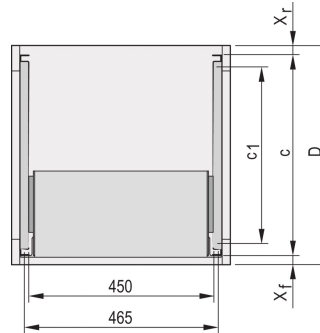
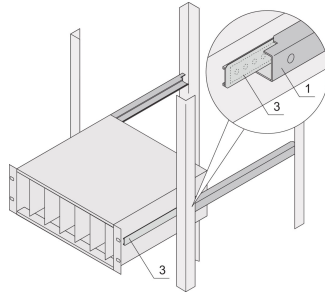
24562-473



Telescopic slides with guiding profile for fitting in cabinets with 25 kg load capacity.

??



??

For mounting 84 HP wide subracks in the 19" plane

Loading capacity: 25 kg per pair

The guiding profile (1) is matched to the fixing dimension in the cabinet (it is bolted to the 19" profile of the cabinet); the adaptor Rail (3) is matched to the depth and fixing dimension on the subrack (it is inserted into the guiding profile like a telescopic slide)

????

????: Varistar CP

?: 1200mm

????: 2

?: ????

?: ?

????: ????

?: C ??

Net Weight: 1.07kg

??????

No protection against extraction, no stop at full extension.

The reinforcement Rail and the C-Rails have been tested in accordance with the Russian atomic energy authority GAN standards.

??

???? nVent ?????????????????? nVent ??????? www.nvent.com ??????????? nVent ??? nVent
??



??????????:

CADDY ERICO HOFFMAN ILSCO SCHROFF TRACHTE